

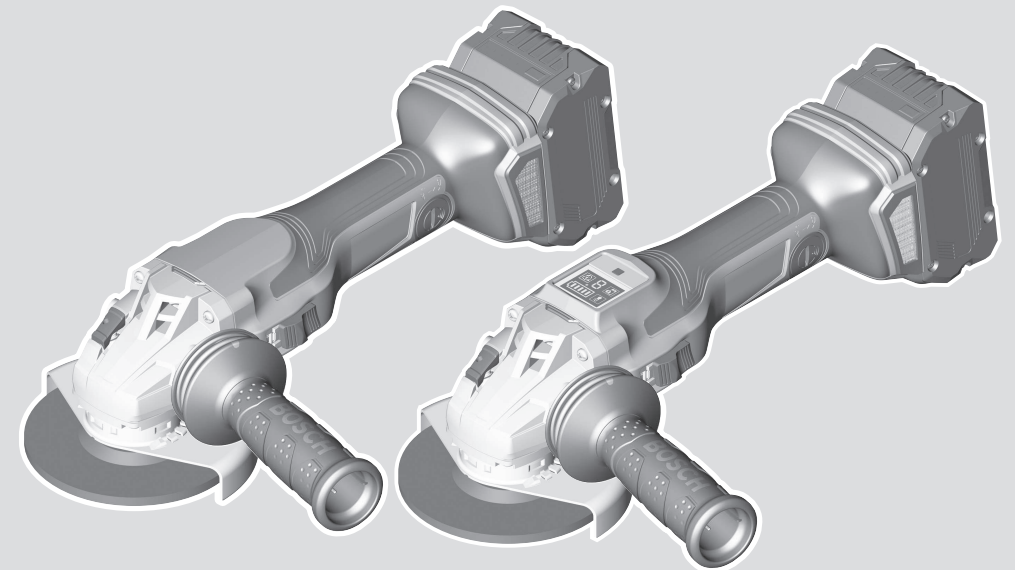

 **BOSCH**

GWS Professional **HEAVY DUTY**

18V-15 C | 18V-15 SC



Robert Bosch Power Tools GmbH
70538 Stuttgart
GERMANY

www.bosch-pt.com

1 609 92A 5RK (2020.10) 0 / 88



1 609 92A 5RK

- en Original instructions
- zh 正本使用说明书
- zh 原始使用說明書
- ko 사용 설명서 원본
- th หนังสือคู่มือการใช้งานฉบับต้นแบบ
- id Petunjuk-Petunjuk untuk Penggunaan Orisinal
- vi Bản gốc hướng dẫn sử dụng



English	Page	6
中文	页	16
繁體中文	頁	26
한국어	페이지	35
ไทย	หน้า	46
Bahasa Indonesia	Halaman	60
Tiếng Việt	Trang	72

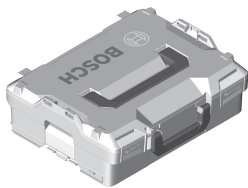

L-BOXX 136
1 600 A01 2G0

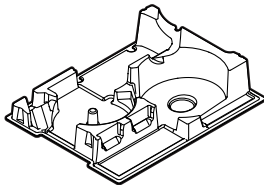

6 082 850 6DU



1 600 A01 3WF

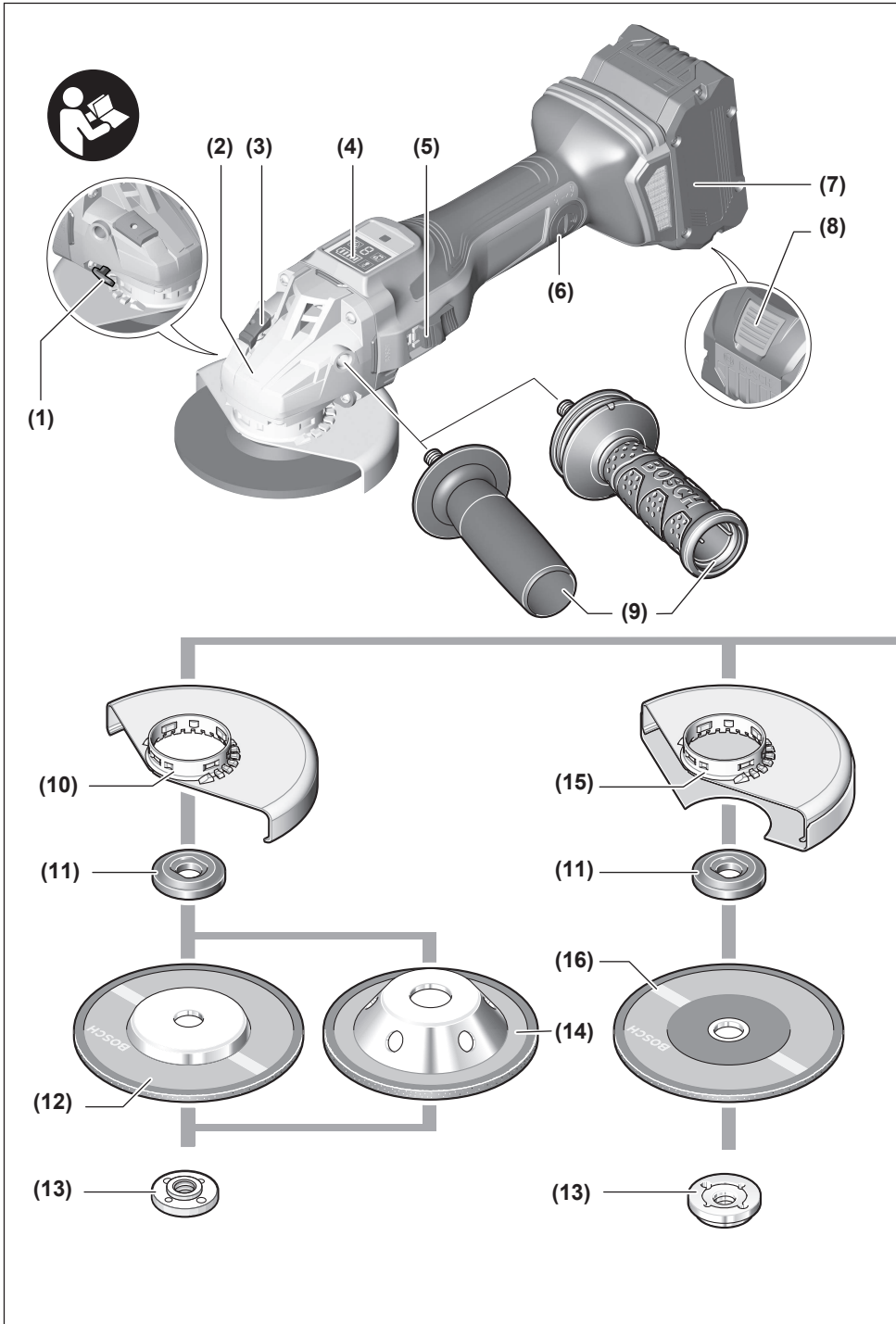

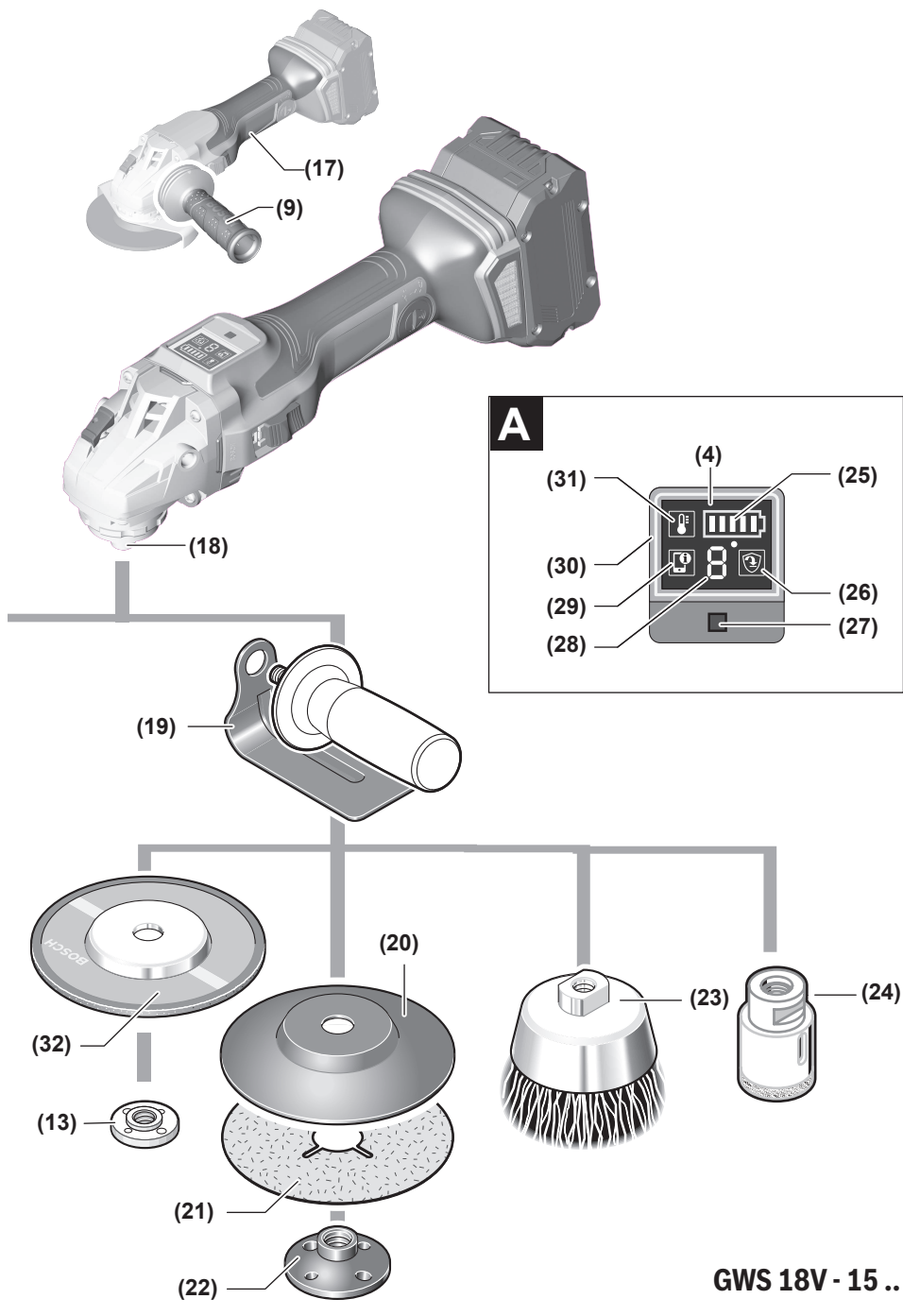

GWS 18V - 15 ..

English

Safety instructions

General Power Tool Safety Warnings

⚠ WARNING **Read all safety warnings and all instructions.** Failure to follow the warnings and instructions may result in electric shock, fire and/or serious injury.

Save all warnings and instructions for future reference.

The term "power tool" in the warnings refers to your mains-operated (corded) power tool or battery-operated (cordless) power tool.

Work area safety

- ▶ **Keep work area clean and well lit.** Cluttered or dark areas invite accidents.
- ▶ **Do not operate power tools in explosive atmospheres, such as in the presence of flammable liquids, gases or dust.** Power tools create sparks which may ignite the dust or fumes.
- ▶ **Keep children and bystanders away while operating a power tool.** Distractions can cause you to lose control.

Electrical safety

- ▶ **Power tool plugs must match the outlet. Never modify the plug in any way. Do not use any adapter plugs with earthed (grounded) power tools.** Unmodified plugs and matching outlets will reduce risk of electric shock.
- ▶ **Avoid body contact with earthed or grounded surfaces, such as pipes, radiators, ranges and refrigerators.** There is an increased risk of electric shock if your body is earthed or grounded.
- ▶ **Do not expose power tools to rain or wet conditions.** Water entering a power tool will increase the risk of electric shock.
- ▶ **Do not abuse the cord. Never use the cord for carrying, pulling or unplugging the power tool. Keep cord away from heat, oil, sharp edges or moving parts.** Damaged or entangled cords increase the risk of electric shock.
- ▶ **When operating a power tool outdoors, use an extension cord suitable for outdoor use.** Use of a cord suitable for outdoor use reduces the risk of electric shock.
- ▶ **If operating a power tool in a damp location is unavoidable, use a residual current device (RCD) protected supply.** Use of an RCD reduces the risk of electric shock.

Personal safety

- ▶ **Stay alert, watch what you are doing and use common sense when operating a power tool. Do not use a power tool while you are tired or under the influence of drugs, alcohol or medication.** A moment of inattention while operating power tools may result in serious personal injury.

- ▶ **Use personal protective equipment. Always wear eye protection.** Protective equipment such as dust mask, non-skid safety shoes, hard hat, or hearing protection used for appropriate conditions will reduce personal injuries.
- ▶ **Prevent unintentional starting. Ensure the switch is in the off-position before connecting to power source and/or battery pack, picking up or carrying the tool.** Carrying power tools with your finger on the switch or energising power tools that have the switch on invites accidents.
- ▶ **Remove any adjusting key or wrench before turning the power tool on.** A wrench or a key left attached to a rotating part of the power tool may result in personal injury.
- ▶ **Do not overreach. Keep proper footing and balance at all times.** This enables better control of the power tool in unexpected situations.
- ▶ **Dress properly. Do not wear loose clothing or jewellery. Keep your hair, clothing and gloves away from moving parts.** Loose clothes, jewellery or long hair can be caught in moving parts.
- ▶ **If devices are provided for the connection of dust extraction and collection facilities, ensure these are connected and properly used.** Use of dust collection can reduce dust-related hazards.

Power tool use and care

- ▶ **Do not force the power tool. Use the correct power tool for your application.** The correct power tool will do the job better and safer at the rate for which it was designed.
- ▶ **Do not use the power tool if the switch does not turn it on and off.** Any power tool that cannot be controlled with the switch is dangerous and must be repaired.
- ▶ **Disconnect the plug from the power source and/or the battery pack from the power tool before making any adjustments, changing accessories, or storing power tools.** Such preventive safety measures reduce the risk of starting the power tool accidentally.
- ▶ **Store idle power tools out of the reach of children and do not allow persons unfamiliar with the power tool or these instructions to operate the power tool.** Power tools are dangerous in the hands of untrained users.
- ▶ **Maintain power tools. Check for misalignment or binding of moving parts, breakage of parts and any other condition that may affect the power tool's operation. If damaged, have the power tool repaired before use.** Many accidents are caused by poorly maintained power tools.
- ▶ **Keep cutting tools sharp and clean.** Properly maintained cutting tools with sharp cutting edges are less likely to bind and are easier to control.
- ▶ **Use the power tool, accessories and tool bits etc. in accordance with these instructions, taking into account the working conditions and the work to be performed.**

formed. Use of the power tool for operations different from those intended could result in a hazardous situation.

Battery tool use and care

- ▶ **Recharge only with the charger specified by the manufacturer.** A charger that is suitable for one type of battery pack may create a risk of fire when used with another battery pack.
- ▶ **Use power tools only with specifically designated battery packs.** Use of any other battery packs may create a risk of injury and fire.
- ▶ **When battery pack is not in use, keep it away from other metal objects, like paper clips, coins, keys, nails, screws or other small metal objects, that can make a connection from one terminal to another.** Shorting the battery terminals together may cause burns or a fire.
- ▶ **Under abusive conditions, liquid may be ejected from the battery; avoid contact. If contact accidentally occurs, flush with water. If liquid contacts eyes, additionally seek medical help.** Liquid ejected from the battery may cause irritation or burns.

Service

- ▶ **Have your power tool serviced by a qualified repair person using only identical replacement parts.** This will ensure that the safety of the power tool is maintained.

Safety information for the angle grinder

Safety Warnings common for Grinding, Sanding, Wire Brushing or Abrasive Cutting Off operations

- ▶ **This power tool is intended to function as a grinder, sander, wire brush or cut-off tool. Read all safety warnings, instructions, illustrations and specifications provided with this power tool.** Failure to follow all instructions listed below may result in electric shock, fire and/or serious injury.
- ▶ **Operations such as polishing are not recommended to be performed with this power tool.** Operations for which the power tool was not designed may create a hazard and cause personal injury.
- ▶ **Do not use accessories which are not specifically designed and recommended by the tool manufacturer.** Just because the accessory can be attached to your power tool, it does not assure safe operation.
- ▶ **The rated speed of the accessory must be at least equal to the maximum speed marked on the power tool.** Accessories running faster than their rated speed can break and fly apart.
- ▶ **The outside diameter and the thickness of your accessory must be within the capacity rating of your power tool.** Incorrectly sized accessories cannot be adequately guarded or controlled.
- ▶ **Threaded mounting of accessories must match the grinder spindle thread. For accessories mounted by flanges, the arbour hole of the accessory must fit the locating diameter of the flange.** Accessories that do not

match the mounting hardware of the power tool will run out of balance, vibrate excessively and may cause loss of control.

- ▶ **Do not use a damaged accessory. Before each use inspect the accessory such as abrasive wheels for chips and cracks, backing pad for cracks, tear or excess wear, wire brush for loose or cracked wires. If power tool or accessory is dropped, inspect for damage or install an undamaged accessory. After inspecting and installing an accessory, position yourself and bystanders away from the plane of the rotating accessory and run the power tool at maximum no load speed for one minute.** Damaged accessories will normally break apart during this test time.
- ▶ **Wear personal protective equipment. Depending on application, use face shield, safety goggles or safety glasses. As appropriate, wear dust mask, hearing protectors, gloves and workshop apron capable of stopping small abrasive or workpiece fragments.** The eye protection must be capable of stopping flying debris generated by various operations. The dust mask or respirator must be capable of filtering particles generated by your operation. Prolonged exposure to high intensity noise may cause hearing loss.
- ▶ **Keep bystanders a safe distance away from work area. Anyone entering the work area must wear personal protective equipment.** Fragments of workpiece or of a broken accessory may fly away and cause injury beyond immediate area of operation.
- ▶ **Hold the power tool by insulated gripping surfaces only, when performing an operation where the cutting accessory may contact hidden wiring.** Cutting accessory contacting a "live" wire may make exposed metal parts of the power tool "live" and could give the operator an electric shock.
- ▶ **Never lay the power tool down until the accessory has come to a complete stop.** The spinning accessory may grab the surface and pull the power tool out of your control.
- ▶ **Do not run the power tool while carrying it at your side.** Accidental contact with the spinning accessory could snag your clothing, pulling the accessory into your body.
- ▶ **Regularly clean the power tool's air vents.** The motor's fan will draw the dust inside the housing and excessive accumulation of powdered metal may cause electrical hazards.
- ▶ **Do not operate the power tool near flammable materials.** Sparks could ignite these materials.
- ▶ **Do not use accessories that require liquid coolants.** Using water or other liquid coolants may result in electrocution or shock.

Kickback and Related Warnings

Kickback is a sudden reaction to a pinched or snagged rotating wheel, backing pad, brush or any other accessory. Pinching or snagging causes rapid stalling of the rotating access-

ory which in turn causes the uncontrolled power tool to be forced in the direction opposite of the accessory's rotation at the point of the binding.

For example, if an abrasive wheel is snagged or pinched by the workpiece, the edge of the wheel that is entering into the pinch point can dig into the surface of the material causing the wheel to climb out or kick out. The wheel may either jump toward or away from the operator, depending on direction of the wheel's movement at the point of pinching. Abrasive wheels may also break under these conditions.

Kickback is the result of power tool misuse and/or incorrect operating procedures or conditions and can be avoided by taking proper precautions as given below.

- ▶ **Maintain a firm grip on the power tool and position your body and arm to allow you to resist kickback forces. Always use auxiliary handle, if provided, for maximum control over kickback or torque reaction during start-up.** The operator can control torque reactions or kickback forces, if proper precautions are taken.
- ▶ **Never place your hand near the rotating accessory.** Accessory may kickback over your hand.
- ▶ **Do not position your body in the area where power tool will move if kickback occurs.** Kickback will propel the tool in direction opposite to the wheel's movement at the point of snagging.
- ▶ **Use special care when working corners, sharp edges etc. Avoid bouncing and snagging the accessory.** Corners, sharp edges or bouncing have a tendency to snag the rotating accessory and cause loss of control or kickback.
- ▶ **Do not attach a saw chain woodcarving blade or toothed saw blade.** Such blades create frequent kickback and loss of control.

Safety Warnings specific for Grinding and Abrasive Cutting-Off operations

- ▶ **Use only wheel types that are recommended for your power tool and the specific guard designed for the selected wheel.** Wheels for which the power tool was not designed cannot be adequately guarded and are unsafe.
- ▶ **The grinding surface of centre depressed wheels must be mounted below the plane of the guard lip.** An improperly mounted wheel that projects through the plane of the guard lip cannot be adequately protected.
- ▶ **The guard must be securely attached to the power tool and positioned for maximum safety, so the least amount of wheel is exposed towards the operator.** The guard helps to protect operator from broken wheel fragments, accidental contact with wheel and sparks that could ignite clothing.
- ▶ **Wheels must be used only for recommended applications. For example: do not grind with the side of cut-off wheel.** Abrasive cut-off wheels are intended for peripheral grinding, side forces applied to these wheels may cause them to shatter.
- ▶ **Always use undamaged wheel flanges that are of correct size and shape for your selected wheel.** Proper

wheel flanges support the wheel thus reducing the possibility of wheel breakage. Flanges for cut-off wheels may be different from grinding wheel flanges.

- ▶ **Do not use worn down wheels from larger power tools.** Wheel intended for larger power tool is not suitable for the higher speed of a smaller tool and may burst.

Additional Safety Warnings specific for Abrasive Cutting Off operations

- ▶ **Do not "jam" the cut-off wheel or apply excessive pressure. Do not attempt to make an excessive depth of cut.** Overstressing the wheel increases the loading and susceptibility to twisting or binding of the wheel in the cut and the possibility of kickback or wheel breakage.
- ▶ **Do not position your body in line with and behind the rotating wheel.** When the wheel, at the point of operation, is moving away from your body, the possible kickback may propel the spinning wheel and the power tool directly at you.
- ▶ **When wheel is binding or when interrupting a cut for any reason, switch off the power tool and hold the power tool motionless until the wheel comes to a complete stop. Never attempt to remove the cut-off wheel from the cut while the wheel is in motion otherwise kickback may occur.** Investigate and take corrective action to eliminate the cause of wheel binding.
- ▶ **Do not restart the cutting operation in the workpiece. Let the wheel reach full speed and carefully re-enter the cut.** The wheel may bind, walk up or kickback if the power tool is restarted in the workpiece.
- ▶ **Support panels or any oversized workpiece to minimize the risk of wheel pinching and kickback.** Large workpieces tend to sag under their own weight. Supports must be placed under the workpiece near the line of cut and near the edge of the workpiece on both sides of the wheel.
- ▶ **Use extra caution when making a "pocket cut" into existing walls or other blind areas.** The protruding wheel may cut gas or water pipes, electrical wiring or objects that can cause kickback.

Safety Warnings specific for Sanding operations

- ▶ **Do not use excessively oversized sanding disc paper. Follow manufacturers recommendations, when selecting sanding paper.** Larger sanding paper extending beyond the sanding pad presents a laceration hazard and may cause snagging, tearing of the disc, or kickback.

Safety Warnings specific for Wire Brushing operations

- ▶ **Be aware that wire bristles are thrown by the brush even during ordinary operation. Do not overstress the wires by applying excessive load to the brush.** The wire bristles can easily penetrate light clothing and/or skin.
- ▶ **If the use of a guard is recommended for wire brushing, do not allow any interference of the wire wheel or brush with the guard.** Wire wheel or brush may expand in diameter due to work load and centrifugal forces.

Additional safety information



Wear safety goggles.

- ▶ **Use suitable detectors to determine if there are hidden supply lines or contact the local utility company for assistance.** Contact with electric cables can cause fire and electric shock. Damaging gas lines can lead to explosion. Breaking water pipes causes property damage.
- ▶ **Do not touch grinding and cutting discs until they have cooled down.** The discs can become very hot while working.
- ▶ **Release the On/Off switch and set it to the Off position when the power supply is interrupted, e.g. when the battery pack is removed.** This prevents uncontrolled restarting.
- ▶ **Secure the workpiece.** A workpiece clamped with clamping devices or in a vice is held more secure than by hand.
- ▶ **In case of damage and improper use of the battery, vapours may be emitted. The battery can set alight or explode.** Ensure the area is well ventilated and seek medical attention should you experience any adverse effects. The vapours may irritate the respiratory system.
- ▶ **Do not open the battery.** There is a risk of short-circuiting.
- ▶ **The battery can be damaged by pointed objects such as nails or screwdrivers or by force applied externally.** An internal short circuit may occur, causing the battery to burn, smoke, explode or overheat.
- ▶ **Only use the battery with products from the manufacturer.** This is the only way in which you can protect the battery against dangerous overload.



Protect the battery against heat, e.g. against continuous intense sunlight, fire, dirt, water and moisture. There is a risk of explosion and short-circuiting.



- ▶ **Caution! When using the power tool with Bluetooth[®], a fault may occur in other devices and systems, aeroplanes and medical devices (e.g. pacemakers, hearing aids). Also, damage to people and animals in the immediate vicinity cannot be completely excluded. Do not use the power tool with Bluetooth[®] in the vicinity of medical devices, petrol stations, chemical plants, areas with a potentially explosive atmosphere or in blasting areas. Do not use the power tool with Bluetooth[®] in aircraft. Avoid using the product near your body for extended periods.**

The Bluetooth[®] word mark and logos are registered trademarks owned by Bluetooth SIG, Inc. and any use of such marks by Robert Bosch Power Tools GmbH is under license.

Product Description and Specifications



Read all the safety and general instructions.

Failure to observe the safety and general instructions may result in electric shock, fire and/or serious injury.

Please observe the illustrations at the beginning of this operating manual.

Intended use

The power tool is intended for cutting, roughing and brushing metal and stone materials without the use of water.

A special protective guard for cutting must be used when cutting bonded abrasives.

Sufficient dust extraction must be provided when cutting stone.

With approved abrasive tools, the power tool can be used for sanding with sanding discs.

With the Bluetooth[®] Low Energy Module **GCY 42** inserted, power tool data and settings can be transferred between the power tool and a mobile device by means of Bluetooth[®] wireless technology.

Product Features

The numbering of the product features refers to the diagram of the power tool on the graphics page.

- (1) Unlocking lever for protective guard
- (2) Direction of rotation arrow on housing
- (3) Spindle lock button
- (4) User interface
- (5) On/off switch
- (6) Cover for GCY 42 Bluetooth[®] Low Energy Module
- (7) Battery^{A)}
- (8) Battery release button^{A)}
- (9) Auxiliary handle (insulated gripping surface)
- (10) Protective guard for grinding
- (11) Mounting flange with O-ring
- (12) Grinding disc
- (13) Clamping nut
- (14) Carbide grinding head^{A)}
- (15) Protective guard for cutting^{A)}
- (16) Cutting disc^{A)}
- (17) Handle (insulated gripping surface)
- (18) Grinding spindle
- (19) Hand guard^{A)}
- (20) Rubber sanding pad^{A)}
- (21) Abrasive disc^{A)}
- (22) Round nut^{A)}
- (23) Cup brush^{A)}
- (24) Diamond core bit^{A)}

- (25) Battery charge indicator (user interface)
 (26) Kickback shutdown indicator (user interface)
 (27) Speed preselection button (user interface)
 (28) Speed setting/mode indicator (user interface)
 (29) Smartphone indicator (user interface)
- (30) Power tool status indicator (user interface)
 (31) Temperature indicator (user interface)
 (32) Flap disc^{A)}
- A) **Accessories shown or described are not included with the product as standard. You can find the complete selection of accessories in our accessories range.**

Technical Data

Angle grinder		GWS 18V-15 C	GWS 18V-15 SC
Article number		3 601 JH6 0..	3 601 JH6 1..
Rated voltage	V=	18	18
Rated speed ^{A)}	min ⁻¹	11,000	11,000
No-load speed ^{B)}	min ⁻¹	9800	3400–9800
Max. grinding disc diameter	mm	100	100
Grinding spindle thread		M 10	M 10
Max. thread length of grinding spindle	mm	16	16
Kickback stop		●	●
Restart protection		●	●
Run-out brake		●	●
Speed preselection		–	●
Weight according to EPTA-Procedure 01:2014 ^{C)}			
– with low-vibration auxiliary handle	kg	2.5–3.5	2.5–3.5
– with standard auxiliary handle	kg	2.3–3.3	2.3–3.3
Recommended ambient temperature during charging	°C	0 ... +35	0 ... +35
Permitted ambient temperature during operation ^{D)} and during storage	°C	–20 ... +50	–20 ... +50
Compatible rechargeable batteries		GBA 18V... ProCORE18V...	GBA 18V... ProCORE18V...
Recommended rechargeable batteries for maximum performance		ProCORE18V... ≥ 5.5 Ah	ProCORE18V... ≥ 5.5 Ah
Recommended chargers		GAL 18... GAX 18... GAL 36...	GAL 18... GAX 18... GAL 36...

Data transmission

Bluetooth®		Bluetooth® 4.2 (Low Energy) ^{E)}	Bluetooth® 4.2 (Low Energy) ^{E)}
Signal interval	s	8	8
Max. signal range ^{F)}	m	30	30

A) Rated speed in accordance with EN 60745-2-3

B) Measured at 20–25 °C with rechargeable battery ProCORE18V 8.0Ah and depending on the battery's state of charge as well as the tool's operating temperature

C) Depends on battery in use

D) Limited performance at temperatures <0 °C

E) The mobile terminal devices must be compatible with Bluetooth® Low Energy devices (version 4.2) and support the Generic Access Profile (GAP).

F) The signal range may vary greatly depending on external conditions, including the receiving device used. The Bluetooth® range may be significantly weaker inside closed rooms and through metallic barriers (e.g. walls, shelving units, cases, etc.).

Fitting

Using the GCY 42 Bluetooth® Low Energy Module

Note: The GCY 42 Bluetooth® Low Energy Module is available as an accessory with GWS 18V-15 C power tools; it is included in the scope of delivery for GWS 18V-15 SC power tools.

Read the corresponding operating instructions for information about the Bluetooth® Low Energy Module **GCY 42**.

Charging the battery

- **Use only the chargers listed in the technical data.** Only these chargers are matched to the lithium-ion battery of your power tool.

Note: The battery is supplied partially charged. To ensure full battery capacity, fully charge the battery in the charger before using your power tool for the first time.

The lithium-ion battery can be charged at any time without reducing its service life. Interrupting the charging process does not damage the battery.

The lithium-ion battery is protected against deep discharge by the "Electronic Cell Protection (ECP)". When the battery is discharged, the power tool is switched off by means of a protective circuit: The application tool no longer rotates.

- **Do not continue to press the On/Off switch after the power tool has automatically switched off.** The battery can be damaged.

Follow the instructions on correct disposal.



Removing the Battery

The battery (7) is equipped with two locking levels to prevent the battery from falling out if the battery release button (8) is pressed unintentionally. As long as the battery is inserted in the power tool, it is held in position by means of a spring.

To remove the battery (7), press the release button (8) and pull the battery out of the power tool. **Do not use force to do this.**

Battery charge indicator

The green LEDs on the battery charge indicator indicate the state of charge of the battery. For safety reasons, it is only possible to check the state of charge when the power tool is not in operation.

Press the button for the battery charge indicator  or  to show the state of charge. This is also possible when the battery is removed.

If no LED lights up after pressing the button for the battery charge indicator, then the battery is defective and must be replaced.

Note: The state of charge of the battery is also displayed on the user interface (4) (see "Status Indicators", page 14).

Battery model GBA 18V...



LEDs	Capacity
3× continuous green light	60–100 %
2× continuous green light	30–60 %
1× continuous green light	5–30 %
1× flashing green light	0–5 %

Battery model ProCORE18V...



LEDs	Capacity
5× continuous green light	80–100 %
4× continuous green light	60–80 %
3× continuous green light	40–60 %
2× continuous green light	20–40 %
1× continuous green light	5–20 %
1× flashing green light	0–5 %

Fitting Protective Equipment

- **Remove the battery from the power tool before carrying out work on the power tool (e.g. maintenance, changing tool, etc.). The battery should also be removed for transport and storage.** There is risk of injury from unintentionally pressing the on/off switch.

Note: If the grinding disc breaks during operation or the holding fixtures on the protective guard/power tool become damaged, the power tool must be sent to the after-sales service immediately; see the "After-Sales Service and Application Service" section for addresses.

Protective guard for grinding

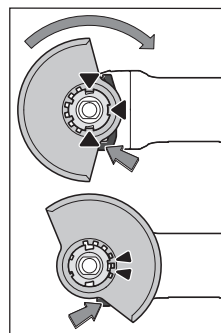

Place the protective guard (10) onto the holder on the power tool until the coding cams of the protective guard are aligned with the holder. When doing so, press and hold the unlocking lever (1). Press the protective guard (10) onto the spindle collar until the shoulder of the protective guard is sitting on the flange of the power tool and rotate the protective guard until it audibly clicks into place.

Adjust the position of the protective guard (10) to meet the requirements of the operation. To do this, push the unlocking lever (1) upward and rotate the protective guard (10) into the required position.

- ▶ **Always position the protective guard (10) such that the two cams on the unlocking lever (1) engage in the corresponding openings on the protective guard (10).**
- ▶ **Adjust the protective guard (10) such that sparking in the direction of the operator is prevented.**
- ▶ **The protective guard (10) must only be adjustable while the unlocking lever (1) is actuated. Otherwise, the power tool must not be used any more under any circumstances and must be sent to the after-sales service.**

Note: The coding cams on the protective guard (10) ensure that only a protective guard that is suitable for the power tool can be fitted.

Protective guard for cutting

- ▶ **Always use the protective guard for cutting (15) when cutting bonded abrasives.**
- ▶ **Provide sufficient dust extraction when cutting stone.**

The protective guard for cutting (15) is fitted in the same way as the protective guard for grinding (10).

Side handle

- ▶ **Do not operate your power tool without the side handle (9).**

Screw the side handle (9) on the left or right of the machine head depending on how you are working.

Low-vibration auxiliary handle



The low-vibration auxiliary handle reduces vibration, enabling the tool to be used safely and more comfortably.

ably.

- ▶ **Do not make any alterations of any kind to the auxiliary handle.**

Do not continue to use a damaged auxiliary handle.

Hand guard

- ▶ **Always fit the hand guard (19) when working with the rubber sanding plate (20) or with the cup brush/disc brush/flap disc.**

Attach the hand guard (19) to the side handle (9).

Fitting the abrasive tools

- ▶ **Remove the battery from the power tool before carrying out work on the power tool (e.g. maintenance, changing tool, etc.). The battery should also be removed for transport and storage.** There is risk of injury from unintentionally pressing the on/off switch.
- ▶ **Do not touch grinding and cutting discs until they have cooled down.** The discs can become very hot while working.

Clean the grinding spindle (18) and all the parts to be fitted.

Lock the grinding spindle with the spindle lock button (3) before clamping and releasing the abrasive tools.

- ▶ **Do not press the spindle lock button while the grinding spindle is moving.** The power tool may become damaged if you do this.

Grinding/Cutting Disc

Pay attention to the dimensions of the grinding tools. The mounting hole diameter must fit the mounting flange without play. Do not use reducers or adapters.

When using diamond cutting discs, pay attention that the direction-of-rotation arrow on the diamond cutting disc and the direction of rotation of the machine (see direction-of-rotation arrow on the machine head) agree.

See graphics page for the mounting sequence.

To fasten the grinding/cutting disc, screw on the clamping nut (13) and tighten with the two-hole spanner.

- ▶ **After fitting the abrasive tool, check that the abrasive tool is fitted correctly and can turn freely before switching on the power tool. Make sure that the abrasive tool does not brush against the protective guard or other parts.**

Flap disc

- ▶ **Always fit the hand guard (19) when working with the flap disc.**

Rubber Sanding Pad

- ▶ **Always fit the hand guard (19) when working with the rubber sanding pad (20).**

See the graphics page for fitting instructions.

Slide the rubber sanding pad (20) onto the grinding spindle (18).

Press the sanding sheet (21) firmly onto the underside of the rubber sanding pad (20).

Screw on the round nut (22) and tighten with a two-pin spanner.

Cup brush/disc brush

- ▶ **Always fit the hand guard (19) when working with the cup brush or disc brush.**

See the graphics page for fitting instructions.

The cup brush/disc brush must be screwed onto the grinding spindle until it rests firmly against the grinding spindle flange at the end of the grinding spindle thread. Tighten the cup brush/disc brush with an open-ended spanner.

Carbide Grinding Head





- ▶ **A grinding head may be used only with a suitable protective guard.**

Approved abrasive tools

You can use all the abrasive tools mentioned in these operating instructions.

The permissible speed [min^{-1}] or the circumferential speed [m/s] of the abrasive tools used must at least match the values given in the table.

It is therefore important to observe the permissible **rotational/circumferential speed** on the label of the abrasive tool.

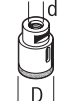
	max. [mm]	[mm]		
	D	b	d	[min ⁻¹] [m/s]
	100	7	16	11,000 80
	100	-	-	11,000 80
	75	30	M 14	11,000 45
	82	-	M 14	11,000 80

Rotating the Machine Head (GWS 18V-15 C)

- **Remove the battery from the power tool before carrying out work on the power tool (e.g. maintenance, changing tool, etc.). The battery should also be removed for transport and storage.** There is risk of injury from unintentionally pressing the on/off switch.

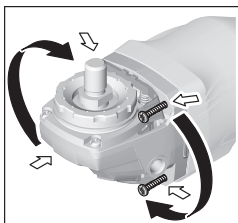

The machine head can be rotated in 90° increments. In this way, the on/off switch can be brought into a more favourable handling position for particular applications, e.g. for left-handed tool users.

Completely unscrew the four screws. Rotate the ma-

chine head carefully, **without removing it from the housing**, into the new position. Screw in and retighten the four screws.

Dust/Chip Extraction

Dust from materials such as lead-containing coatings, some wood types, minerals and metal can be harmful to one's health. Touching or breathing-in the dust can cause allergic reactions and/or lead to respiratory infections of the user or bystanders.

Certain dust, such as oak or beech dust, is considered carcinogenic, especially in connection with wood-treatment additives (chromate, wood preservative). Materials containing asbestos may only be worked by specialists.

- Provide for good ventilation of the working place.
- It is recommended to wear a P2 filter-class respirator.

Observe the relevant regulations in your country for the materials to be worked.

Speed Preselection (GWS 18V-15 SC)

The factory settings include three preset speeds. Using a special application (Bosch Toolbox app), up to six speed settings can be programmed.

- **Avoid dust accumulation at the workplace.** Dust can easily ignite.

Operation

Start-up

Inserting the battery

Push the charged battery (7) into the base of the power tool from the front until the battery is securely locked.

Switching on/off

To **start** the power tool, push the on/off switch (5) forward.

To **lock** the on/off switch (5) in position, push the on/off switch (5) forward and down until it clicks into place.

To **switch off** the power tool, release the on/off switch (5); or, if the switch is locked, briefly push the on/off switch (5) backward and down and then release it.

- **Always check abrasive tools before using them. The abrasive tool must be fitted properly and be able to move freely. Carry out a test run for at least one minute with no load. Do not use abrasive tools that are damaged, run untrue or vibrate during use.** Damaged abrasive tools can burst apart and cause injuries.

Kickback stop



If there is a sudden kickback in the power tool, e.g. jamming in a separating cut, the power supply to the motor will be interrupted electronically. The kickback stop indicator (26) then lights up. When kickback stop is activated, the status indicator (30) flashes red.

To **restart** the tool, set the on/off switch (5) to the off position and then switch the power tool on again.

Restart protection

The restart protection feature prevents the power tool from starting unintentionally after the power supply to it has been interrupted.

When restart protection is activated, the status indicator (30) flashes red.

To **restart** the tool, set the on/off switch (5) to the off position and then switch the power tool on again.

Impact shutdown

The integrated impact shutdown switches the power tool off as soon as it hits the floor. The status indicator (30) then flashes red.

To **restart** the tool, set the on/off switch (5) to the off position and then switch the power tool on again.

User interface (see figure A)

The user interface (4) is used to preselect the speed and to indicate the status of the power tool.

If the number of speeds is changed, the values of the preset individual speed settings are adjusted. In this case, the speed setting/mode indicator **(28)** lights up white. If a speed value is individually programmed, the speed setting/mode indicator **(28)** lights up blue for this speed setting (i.e. does not correspond to a default setting). It is possible to individually adjust the speed settings in steps of 200 min^{-1} . Keep in mind the logically ascending sequence of the settings ($2 \geq 1$, $3 \geq 2$, etc.) when doing so. The following table shows the preset speeds (default settings) for each programmed number of settings.

GWS 18V-15 SC	Basic speed setting at level					
	1	2	3	4	5	6
	[min^{-1}]	[min^{-1}]	[min^{-1}]	[min^{-1}]	[min^{-1}]	[min^{-1}]
Number of speed settings						
1	3400	–	–	–	–	–
2	3400	9800	–	–	–	–
3	3400	6600	9800	–	–	–
4	3400	5600	7600	9800	–	–
5	3400	5000	6600	8200	9800	–
6	3400	4600	6000	7200	8600	9800

The specified speed setting values depend on the rechargeable battery in use, the battery's state of charge and the tool's operating temperature. You can use the button for speed preselection **(27)** to preselect the required speed, even during operation. The information in the table below describes the recommended values for the default settings with 3 preset speed levels.

Material	Application	Application tool	Speed preselection level	GWS 18V-15 SC [min^{-1}]
Metal	Brushing, removing rust	Cup brush	1	3400
Stainless steel	Grinding	Fibre disc	2	6600
Metal	Rough grinding	Grinding disc	3	max.
Metal	Cutting	Grinding disc	3	max.
Stone	Cutting	Diamond cutting disc and cutting guide (cutting of stone is permitted only with a cutting guide)	3	max.

► **The rated speed of the accessory must be at least equal to the maximum speed marked on the power**

tool. Accessories running faster than their rated speed can break and fly apart.

Status indications

Battery charge indicator (user interface) (25)	Meaning/cause	Solution
Green	Battery charged	–
Yellow	Battery almost empty	Replace or charge battery soon
Red	Battery empty	Replace or charge battery

Temperature indicator (31)	Meaning/cause	Solution
Yellow	Critical temperature has been reached (motor, electronics, battery)	Run the power tool at no load and allow it to cool down
Red	Power tool is overheated and will switch off	Leave the power tool to cool down

Power tool status indicator (30)	Meaning/cause	Solution
Green	Status OK	–
Yellow	Critical temperature has been reached or battery is almost empty	Run the power tool at no load and allow it to cool down, or replace or charge the battery soon

Power tool status indicator (30)	Meaning/cause	Solution
Illuminated red	Power tool has overheated or battery is empty	Allow the power tool to cool down, or replace or charge the battery
Flashing red	Kickback shutdown, restart protection or impact shutdown has been triggered	Turn the power tool off and on again
Flashing blue	Power tool is connected to a mobile device or settings are being transferred	–

Connectivity functions

In conjunction with the *Bluetooth*® Low Energy Module **GCY 42**, the following connectivity functions are available for the power tool:

- Registration and personalisation
- Status check, output of warning messages
- General information and settings
- Management

Read the corresponding operating instructions for information about the *Bluetooth*® Low Energy Module **GCY 42**.

The connection of the power tool with the app must be confirmed by pressing the speed preselection button **(27)** on the user interface **(4)**. The app requests this when connecting.

Practical advice

- ▶ **With the *Bluetooth*® Low Energy Module GCY 42, the power tool is equipped with a radio interface. Local operating restrictions, e.g. in aircraft or hospitals, must be observed.**
- ▶ **In areas where the *Bluetooth*® wireless technology is not allowed to be used, the *Bluetooth*® Low Energy Module GCY 42 and the button cell must be removed.**
- ▶ **Exercise caution when cutting slots in structural walls; see the "Information on structural design" section.**
- ▶ **Clamp the workpiece if it is not secure under its own weight.**
- ▶ **Do not load the power tool so heavily that it comes to a stop.**
- ▶ **If the power tool has been subjected to a heavy load, continue to run it at no-load for several minutes to cool down the accessory.**
- ▶ **Do not use the power tool with a cut-off stand.**
- ▶ **Do not touch grinding and cutting discs until they have cooled down.** The discs can become very hot while working.

If the power tool becomes electrostatically charged, the built-in electronics will switch the power tool off. Press the on/off switch **(5)** again to restart the power tool.

Rough grinding

- ▶ **Never use cutting discs for rough grinding.**

The best rough grinding results are achieved with a set angle of 30° to 40°. Move the power tool back and forth with moderate pressure. This will ensure that the workpiece does not

become too hot or discolour and that grooves are not formed.

Flap disc

The flap disc (accessory) enables you to machine curved surfaces and profiles.

Flap discs have a considerably longer service life, lower noise levels and lower sanding temperatures than conventional grinding discs.

Cutting metal

- ▶ **Always use the protective guard for cutting (15) when cutting bonded abrasives.**

When carrying out abrasive cutting, use a moderate feed that is suited to the material being machined. Do not exert pressure on the cutting disc and do not tilt or swing the power tool.

Do not attempt to reduce the speed of a cutting disc coming to a stop by applying pressure from the side.

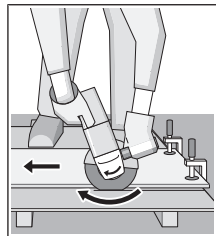

The power tool must always work in an up-grinding motion. Otherwise there is a risk that it will be pushed **uncontrolled** out of the cut.

For best results when cutting profiles and rectangular tubing, start at the smallest cross section.

Cutting stone

- ▶ **Provide sufficient dust extraction when cutting stone.**
- ▶ **Wear a dust mask.**
- ▶ **The power tool may be used only for dry cutting/grinding.**

For best results when cutting stone, use a diamond cutting disc.

When cutting especially hard materials such as concrete with a high pebble content, the diamond cutting disc can overheat and become damaged as a result. This is clearly indicated by circular sparking, rotating with the diamond cutting disc.

If this happens, stop cutting and allow the diamond cutting disc to cool down by running the power tool for a short time at maximum speed with no load.

Working noticeably slower and with circular sparking indicate that the diamond cutting disc that has become dull. You

can sharpen the disc by briefly cutting into abrasive material (e.g. lime-sand brick).

Information on structural design

Slots in load-bearing walls are subject to DIN 1053 part 1 or country-specific regulations. These regulations must be observed under all circumstances. Seek advice from the responsible structural engineer, architect or construction supervisor before starting work.

Recommendations for optimal handling of the battery

Protect the battery against moisture and water.

Only store the battery only within a temperature range of -20 to 50 °C. Do not leave the battery in your car in the summer, for example.

Occasionally clean the ventilation slots on the battery using a soft brush that is clean and dry.

A significantly reduced operating time after charging indicates that the battery has deteriorated and must be replaced. Follow the instructions on correct disposal.

Maintenance and Service

Maintenance and Cleaning

- ▶ **Remove the battery from the power tool before carrying out work on the power tool (e.g. maintenance, changing tool, etc.). The battery should also be removed for transport and storage.** There is risk of injury from unintentionally pressing the on/off switch.
- ▶ **To ensure safe and efficient operation, always keep the power tool and the ventilation slots clean.**

Store and handle the accessories carefully.

After-Sales Service and Application Service

Our after-sales service responds to your questions concerning maintenance and repair of your product as well as spare parts. You can find explosion drawings and information on spare parts at: www.bosch-pt.com

The Bosch product use advice team will be happy to help you with any questions about our products and their accessories.

In all correspondence and spare parts orders, please always include the 10-digit article number given on the nameplate of the product.

Malaysia

Robert Bosch Sdn. Bhd. (220975-V) PT/SMY
No. 8A, Jalan 13/6
46200 Petaling Jaya
Selangor
Tel.: (03) 79663194
Toll-Free: 1800 880188
Fax: (03) 79583838
E-Mail: kiathoe.chong@my.bosch.com
www.bosch-pt.com.my

You can find further service addresses at:

www.bosch-pt.com/serviceaddresses

Transport

The contained lithium-ion batteries are subject to the Dangerous Goods Legislation requirements. The batteries are suitable for road-transport by the user without further restrictions.

When shipping by third parties (e.g.: by air transport or forwarding agency), special requirements on packaging and labelling must be observed. For preparation of the item being shipped, consulting an expert for hazardous material is required.

Dispatch battery packs only when the housing is undamaged. Tape or mask off open contacts and pack up the battery in such a manner that it cannot move around in the packaging. Please also observe the possibility of more detailed national regulations.

Disposal



Power tools, rechargeable batteries, accessories and packaging should be sorted for environmental-friendly recycling.



Do not dispose of power tools and batteries/rechargeable batteries into household waste!

Battery packs/batteries:

Li-ion:

Please observe the notes in the section on transport (see "Transport", page 16).

中文

安全规章

电动工具通用安全警告

警告！

阅读所有警告和所有说明！ 不遵照以下警告和说明会导致电

击、着火和 / 或严重伤害。

保存所有警告和说明书以备查阅。

在所有下列的警告中术语"电动工具"指市电驱动（有线）电动工具或电池驱动（无线）电动工具。

工作场地的安全

- ▶ **保持工作场地清洁和明亮。** 混乱和黑暗的场地会引发事故。
- ▶ **不要在易爆环境，如有易燃液体、气体或粉尘的环境下操作电动工具。** 电动工具产生的火花会点燃粉尘或气体。
- ▶ **让儿童和旁观者离开后操作电动工具。** 注意力不集中会使操作者失去对工具的控制。

电气安全

- ▶ **电动工具插头必须与插座相配。** 绝不能以任何方式改装插头。需接地的电动工具不能使用任何转

换插头。未经改装的插头和相配的插座将减少电击危险。

- ▶ 避免人体接触接地表面，如管道、散热片和冰箱。如果你身体接地会增加电击危险。
- ▶ 不得将电动工具暴露在雨中或潮湿环境中。水进入电动工具将增加电击危险。
- ▶ 不得滥用电线。绝不能用电线搬运、拉动电动工具或拔出其插头。使电线远离热源、油、锐边或运动部件。受损或缠绕的软线会增加电击危险。
- ▶ 当在户外使用电动工具时，使用适合户外使用的外接软线。适合户外使用的软线将减少电击危险。
- ▶ 如果在潮湿环境下操作电动工具是不可避免的，应使用剩余电流动作保护器（RCD）。使用RCD可减小电击危险。

人身安全

- ▶ 保持警觉，当操作电动工具时关注所从事的操作并保持清醒。当你感到疲倦，或在有药物、酒精或治疗反应时，不要操作电动工具。在操作电动工具时瞬间的疏忽会导致严重人身伤害。
- ▶ 使用个人防护装置。始终佩戴护目镜。安全装置，诸如适当条件下使用防尘面具、防滑安全鞋、安全帽、听力防护等装置能减少人身伤害。
- ▶ 防止意外起动。确保开关在连接电源和/或电池盒、拿起或搬运工具时处于关断位置。手指放在已接通电源的开关上或开关处于接通时插入插头可能会导致危险。
- ▶ 在电动工具接通之前，拿掉所有调节钥匙或扳手。遗留在电动工具旋转零件上的扳手或钥匙会导致人身伤害。
- ▶ 手不要伸展得太长。时刻注意立足点和身体平衡。这样在意外情况下能很好地控制电动工具。
- ▶ 着装适当。不要穿宽松衣服或佩戴饰品。让衣服、手套和头发远离运动部件。宽松衣服、配饰或长发可能会卷入运动部件中。
- ▶ 如果提供了与排屑、集尘设备连接用的装置，要确保他们连接完好且使用得当。使用这些装置可减少尘屑引起的危险。

电动工具使用和注意事项

- ▶ 不要滥用电动工具，根据用途使用适当的电动工具。选用适当设计的电动工具会使你工作更有效、更安全。
- ▶ 如果开关不能接通或关断工具电源，则不能使用该电动工具。如果开关不能接通或关断工具电源，则不能使用该电动工具。
- ▶ 在进行任何调节、更换附件或贮存电动工具之前，必须从电源上拔掉插头和/或使电池盒与工具脱离。这种防护性措施将减少工具意外起动的危险。
- ▶ 将闲置不用的电动工具贮存在儿童所及范围之外，并且不要让不熟悉电动工具或对这些说明不了解的人操作电动工具。电动工具在未经培训的用户手中是危险的。
- ▶ 保养电动工具。检查运动件是否调整到位或卡住，检查零件破损情况和影响电动工具运行的其

他状况。如有损坏，电动工具应在使用前修好。许多事故由维护不良的电动工具引发。

- ▶ 保持切削刀具锋利和清洁。保养良好的有锋利切削刃的刀具不易卡住而且容易控制。
- ▶ 按照使用说明书，考虑作业条件和进行的作业来使用电动工具、附件和工具的刀头等。将电动工具用于那些与其用途不符的操作可能会导致危险。

电池式工具使用和注意事项

- ▶ 只用制造商规定的充电器充电。将适用于某种电池盒的充电器用到其他电池盒时会发生着火危险。
- ▶ 只有在配有专用电池盒的情况下才使用电动工具。使用其他电池盒会发生损坏和着火危险。
- ▶ 当电池盒不用时，将它远离其他金属物体，例如回形针、硬币、钥匙、钉子、螺钉或其他小金属物体，以防一端与另一端连接。电池端部短路会引起燃烧或火灾。
- ▶ 在滥用条件下，液体会从电池中溅出；避免接触。如果意外碰到了，用水冲洗。如果液体碰到了眼睛，还要寻求医疗帮助。从电池中溅出的液体会发生腐蚀或燃烧。

维修

- ▶ 让专业维修人员使用相同的备件维修电动工具。这将保证所维修的电动工具的安全。

针对角磨机的安全规章

砂磨、砂光、钢丝砂光或砂磨切割操作的通用安全警告

- ▶ 该电动工具是用于实现砂轮机、砂光机、钢丝刷或切断工具功能的。阅读随该电动工具提供的所有安全警告、说明、图解和规定。不了解以下所列所有说明将导致电击、着火和/或严重伤害。
- ▶ 不推荐用该电动工具进行抛光操作。电动工具不按指定的功能去操作，可能发生危险和引起人身伤害。
- ▶ 不使用非工具制造商推荐和专门设计的附件。否则该附件可能被装到你的电动工具上，而它不能保证安全操作。
- ▶ 附件的额定速度必须至少等于电动工具上标出的最大速度。附件以比其额定速度大的速度运转会发生爆裂和飞溅。
- ▶ 附件的外径和厚度必须在电动工具额定能力范围之内。不正确的附件尺寸不能得到充分防护或控制。
- ▶ 砂轮、法兰盘、靠背垫或任何其他附近的轴孔尺寸必须适合于安装到电工具的主轴上。带轴孔的、与电动工具安装件不配的附件将会失稳、过度振动并会引起失控。
- ▶ 不要使用损坏的附件。在每次使用前要检查附件，例如砂轮是否有碎片和裂缝，靠背垫是否有裂缝，撕裂或过度磨损，钢丝刷是否松动或金属丝是否断裂。如果电动工具或附件脱落了，检查是否有损坏或安装没有损坏的附件。检查和安装附件后，让自己和旁观者的位置远离旋转附件的

平面，并以电动工具最大空载速度运行1分钟。损坏的附件通常在该试验时会碎裂。

- ▶ **戴上防护用品。**根据适用情况，使用面罩，安全护目镜或安全眼镜。适用时，戴上防尘面具，听力保护器，手套和能挡小磨料或工件碎片的工作围裙。眼防护罩必须挡住各种操作产生的飞屑。防尘面具或口罩必须能够过滤操作产生的颗粒。长期暴露在高强度噪音中会引起失聪。
- ▶ **让旁观者与工作区域保持一安全距离。**任何进入工作区域的人必须戴上防护用品。工件或破损附件的碎片可能会飞出并引起紧靠着操作区域的旁观者的伤害。切割附件触及带电导线会使电动工具外露的金属零件带电，并使操作者触电。
- ▶ **当在切割附件有可能切割到暗线的场所进行操作时，只能通过绝缘握持面来握住电动工具。**切割附件碰到一根带电导线可能会使电动工具外露的金属零件带电并使操作者发生电击危险。
- ▶ **直到附件完全停止运动才放下电动工具。并且不得使用任何外力迫使金刚石切割片停转。**旋转的附件可能会抓住表面并拉动电动工具而让你失去对工具的控制。
- ▶ **当携带电动工具时不要开动它。**意外地触及旋转附件可能会缠绕你的衣服而使附件伤害身体。
- ▶ **经常清理电动工具的通风口。**电动机风扇会将灰尘吸入机壳，过多的金属粉末沉积会导致电气危险。
- ▶ **不要在易燃材料附近操作电动工具。**火星可能会点燃这些材料。
- ▶ **不要使用需用冷却液的附件。**用水或其他冷却液可能导致电腐蚀或电击。

反弹和相关警告

反弹是因卡住或缠绕住的旋转砂轮，靠背垫，钢丝刷或其他附件而产生的突然反作用力。卡住或缠绕会引起旋转附件的迅速堵转，随之使失控的电动工具在卡住点产生与附件旋转方向相反的运动。例如，如果砂轮被工件缠绕或卡住了，伸入卡住点的砂轮边缘可能会进入材料表面而引起砂轮爬出或反弹。砂轮可能飞向或飞离操作者，这取决于砂轮在卡住点的运动方向。在此条件下砂轮也可能碎裂。

反弹是电动工具误用和/或不正确操作工序或条件的结果。可以通过采取以下给出的适当预防措施得以避免。

- ▶ **保持紧握电动工具，使你的身体和手臂处于正确状态以抵抗反弹力。**如有辅助手柄，则要一直使用，以便最大限度地控制住起动时的反弹力或反力矩。采取合适的预防措施，操作者就可以控制反力矩或反弹力。
- ▶ **绝不能将手靠近旋转附件。**附件可能会反弹碰到手。
- ▶ **不要站在发生反弹时电动工具可能移动到的地方。**反弹将在缠绕点驱使工具逆砂轮运动方向运动。
- ▶ **当在尖角、锐边等处作业时要特别小心。**避免附件的弹跳和缠绕。尖角、锐边和弹跳具有缠绕旋转附件的趋势并引起反弹的失控。

- ▶ **不要附装上锯链、木雕刀片或带齿锯片。**这些锯片会产生频繁的反弹和失控。

对磨削和砂磨切割操作的专用安全警告

- ▶ **只使用所推荐的砂轮型号和为选用砂轮专门设计的护罩。**不是为电动工具设计的砂轮不能充分得到防护，是不安全的。
- ▶ **安装弯曲的砂轮时，砂轮的研磨面不可以突出于防护罩缘之外。**防护罩无法遮蔽因为安装不当而突出于防护罩缘之外的砂轮。
- ▶ **防护必须牢固地装在电动工具上，且放置得最具安全性，只有最小的砂轮部分暴露在操作人面前。**护罩帮助操作者免于受到爆裂砂轮片和偶然触及砂轮的危險。
- ▶ **砂轮只用作推荐的用途。**例如：不要用切割砂轮的侧面进行磨削。施加到砂轮侧面的力可能会使其碎裂。
- ▶ **始终为所选砂轮选用未损坏的，有恰当规格和形状的砂轮法兰盘。**合适的砂轮法兰盘支承砂轮可以减小砂轮破裂的可能性。切割砂轮的法兰盘可以不同于砂轮法兰盘。
- ▶ **不要使用从大规格电动工具上用剩的磨损砂轮。**用于大规格电动工具上的砂轮不适用于较小规格工具的高速工况并可能会爆裂。

对砂轮切割操作的附加专用安全警告

- ▶ **不要“夹”住切割砂轮或施加过大的压力。**不要试图做过深的切割。给砂轮施加过应力增加了砂轮在切割时的负载，容易缠绕或卡住，增加了反弹或砂轮爆裂的可能性。
- ▶ **身体不要对着旋转砂轮，也不要站在其后。**当把砂轮从操作者身边的操作点移开时，可能的反弹会使旋转砂轮和电动工具朝你推来。
- ▶ **当砂轮被卡住或无论任何原因而中断切割时，关掉电动工具并握住工具不要动，直到砂轮完全停止。决不要试图当砂轮仍然运转时使切割砂轮脱离切割，否则会发生反弹。**调查并采取校正措施以消除砂轮卡住的原因。
- ▶ **不能在工件上重新启动切割操作。**让砂轮达到全速后再小心地重新进入切割。如果电动工具在工件上重新启动，砂轮可能会卡住、爬出或反弹。
- ▶ **支撑住板材或超大工件可使得砂轮卡住和反弹的危险降到最低限度。**大工件凭借自重而下垂。必须在工件靠近切割线处和砂轮两侧近工件边缘处放置支承。
- ▶ **当进行“盲切割”进入墙体或其他盲区时要格外小心。**伸出的砂轮可能会割到煤气管或水管，电线或由此引起反弹的物体。

砂光操作的专用安全警告

- ▶ **当砂光时，不要使用超大砂盘纸。**选用砂盘纸时应按照制造商的推荐。超出砂光垫盘的大砂盘纸有撕裂的危险并且会引起缠绕、砂盘的撕裂或反弹。

钢丝刷操作的专用安全警告

- ▶ **要意识到即使正常操作时钢丝线也会从刷子甩出。**不要对钢丝刷施加过大的负荷而使得钢丝线

承受过应力。钢丝线可能会轻易刺入薄的衣服和/或皮肤内。

- ▶ 如果建议钢丝刷使用护罩，则不允许该护罩对钢丝轮或钢丝刷有任何干扰。钢丝轮或钢丝刷在工作负荷和离心力作用下直径会变大。

其他安全规章



请佩戴护目镜。

- ▶ 使用合适的侦测装置侦察隐藏的电线，或者向当地的相关单位寻求支援。接触电线可能引起火灾并让操作者触电。损坏了瓦斯管会引起爆炸。如果水管被刺穿了会导致财物损失。
- ▶ 在磨片和切割片尚未冷却之前，切勿抓取。工作时砂轮会变得非常炙热。
- ▶ 如果由于取出充电电池等原因导致电源突然中断，请立即解锁起/停开关并调到关闭位置。这样可以避免机器突然起动。
- ▶ 固定好工件。使用固定装置或老虎钳固定工件，会比用手持握工件更牢固。
- ▶ 如果充电电池损坏或者未按照规定使用，充电电池中会散发出有毒蒸汽。充电电池可能会燃烧或爆炸。工作场所必须保持空气流通，如果身体有任何不适必须马上就医。蒸汽会刺激呼吸道。
- ▶ 切勿打开充电电池。可能造成短路。
- ▶ 钉子、螺丝刀等尖锐物品或外力作用可能会损坏充电电池。有可能出现内部短路、蓄电池燃烧、发出烟雾、爆炸或过热。
- ▶ 只能将此充电电池用在制造商的产品中。这样才能确保充电电池不会过载。



保护充电电池免受高温（例如长期阳光照射）、火焰、脏污、水和湿气的侵害。有爆炸和短路的危险。



- ▶ 注意！在使用有蓝牙功能的电动工具时，其他装置和设备、飞机和医疗器械（例如心脏起搏器、助听器）可能会出现故障。同样不能完全排除周围的人和动物会受到伤害。请不要在医疗设备、加油站、化工厂、有爆炸危险的地区附近和在爆破区内使用有蓝牙功能的电动工具。请勿在飞机上使用有蓝牙功能的电动工具。请避免在身体附近较长时间使用。

蓝牙®文字标记和图形符号（标志）是Bluetooth SIG公司的注册商标和财产。Robert Bosch Power Tools GmbH根据许可使用这些文字标记/图形符号。

产品和性能说明



请阅读所有安全规章和指示。不遵照以下警告和说明可能导致电击、着火和/或严重伤害。

请注意本使用说明书开头部分的图示。

按照规定使用

本电动工具适合在金属和石材上进行切割、粗磨和刷磨，而无需使用水。

使用合成磨料进行切割时，必须使用切割专用防护罩。

切割石材时必须进行足够的集尘。

安装允许的磨具后，也可以使用本电动工具进行砂纸研磨。

装入蓝牙® Low Energy Module **GCY 42**（低能耗模块）后，通过蓝牙®无线技术在电动工具和移动终端设备之间传输电动工具的数据和设置。

插图上的机件

机件的编号和电动工具详解图上的编号一致。

- (1) 针对防护罩的解锁开关
- (2) 机壳上的转向箭头
- (3) 主轴锁定键
- (4) 用户界面
- (5) 电源开关
- (6) Bluetooth®（蓝牙）低能耗模块GCY 42的盖板
- (7) 充电电池^{A)}
- (8) 充电电池解锁按钮^{A)}
- (9) 辅助手柄（绝缘握柄）
- (10) 研磨防护罩
- (11) 带O形环的固定法兰
- (12) 砂轮
- (13) 夹紧螺母
- (14) 硬质合金杯形砂轮^{A)}
- (15) 切割防护罩^{A)}
- (16) 切割片^{A)}
- (17) 手柄（绝缘握柄）
- (18) 研磨主轴
- (19) 护手^{A)}
- (20) 橡胶磨盘^{A)}
- (21) 砂纸^{A)}
- (22) 圆形螺母^{A)}
- (23) 杯形钢丝刷^{A)}
- (24) 金刚石钻头^{A)}
- (25) 充电电池电量指示灯（用户界面）
- (26) 回弹断开指示灯（用户界面）
- (27) 转速预选按键（用户界面）
- (28) 转速等级/模式指示灯（用户界面）
- (29) 智能手机指示灯（用户界面）
- (30) 电动工具状态指示灯（用户界面）
- (31) 温度指示灯（用户界面）
- (32) 千叶砂磨轮^{A)}

A) 图表或说明上提到的附件，并不包含在基本的供货范围中。本公司的附件清单中有完整的附件供应项目。

技术参数

角磨机		GWS 18V-15 C	GWS 18V-15 SC
物品代码		3 601 JH6 0..	3 601 JH6 1..
额定电压	V=	18	18
额定转速 ^{A)}	转/分钟	11000	11000
空载转速 ^{B)}	转/分钟	9800	3400-9800
最大砂轮直径	毫米	100	100
研磨主轴螺纹		M 10	M 10
研磨主轴上的最大螺纹长度	毫米	16	16
回弹断开		●	●
重启保护		●	●
防外滑制动器		●	●
转速预选		-	●
重量符合EPTA-Procedure 01:2014 ^{C)}			
- 带减震辅助手柄	公斤	2.5-3.5	2.5-3.5
- 带标准辅助手柄	公斤	2.3-3.3	2.3-3.3
充电时建议的环境温度	摄氏度	0至+35	0至+35
工作时和存放时允许的环境温度 ^{D)}	摄氏度	-20至+50	-20至+50
兼容的充电电池		GBA 18伏... ProCORE18伏...	GBA 18伏... ProCORE18伏...
推荐的确保全功率的充电电池		ProCORE18伏... ≥ 5.5安培小时	ProCORE18伏... ≥ 5.5安培小时
推荐的充电器		GAL 18... GAX 18... GAL 36...	GAL 18... GAX 18... GAL 36...
数据传输			
蓝牙 ^{E)}		蓝牙 4.2 (低能耗) ^{E)}	蓝牙 4.2 (低能耗) ^{E)}
信号间隔	秒	8	8
信号最大作用距离 ^{F)}	米	30	30

A) 测量转速根据EN 60745-2-3标准

B) 在20-25摄氏度下带18伏8.0安培小时的充电电池ProCORE测得，并与充电电池的充电量以及设备的工作温度有关

C) 视所使用的充电电池而定

D) 温度<0 摄氏度时功率受限

E) 移动终端设备必须可与蓝牙®低能耗装置(版本4.2)兼容并支持通用访问配置(GAP)。

F) 根据外部条件包括所用接收设备的不同，覆盖范围会有很大差别。在封闭的室内以及由于金属障碍物(如墙壁、台架、箱子等)，蓝牙®覆盖范围可能明显缩小。

安装

装入Bluetooth® (蓝牙) 低能耗模块 GCY 42

提示: Bluetooth® (蓝牙) Low Energy Module (低能耗模块) GCY 42作为电动工具GWS 18V-15 C的附件提供; 对于电动工具GWS 18V-15 SC, 则包含在供货范围中。

有关蓝牙®Low Energy Module (低能耗模块) GCY 42的信息请见相应的使用说明。

为充电电池充电

► 请只使用在技术参数中列出的充电器。只有这些充电器才适用于本电动工具上的锂离子电池。

提示: 充电电池在交货时只完成部分充电。首度使用电动工具之前，必须先充足充电电池的电量以确保充电电池的功率。

可以随时为锂离子电池充电，不会缩短电池的使用寿命。如果充电过程突然中断，也不会损坏电池。本锂离子电池配备了电池电子保护装置"Electronic Cell Protection (ECP)"，可以防止电池过度放电。电池的电量如果用尽了，保护开关会自动关闭电动工具：安装在机器上的工具刀头会停止转动。

- ▶ 电动工具被关闭之后，切勿继续按住起停开关。否则可能会损坏电池。

请注意有关废弃处理的规定。

取出充电电池

本充电电池(7)具备双重锁定功能，即使不小心触动了充电电池的解锁按钮(8)，充电电池也不会从机器中掉落下来。只要充电电池安装在电动工具中，就会被弹簧固定在其位置上。

如需取下充电电池(7)，则请按压解锁按钮(8)，并将充电电池从电动工具中拔出。在此过程中请勿过度用力。

充电电池电量指示灯

充电电池电量指示灯的绿色LED灯显示充电电池的电量。基于安全原因，只能在电动工具静止时检查充电电池的电量。

按压充电电量指示灯按键或, 来显示充电电量。也可以在充电电池取下时操作。

如果按压充电电量指示灯按键后没有LED灯亮起，则说明充电电池损坏，必须进行更换。

提示：用户界面(4)上也会显示充电电池的电量。(参见“状态指示灯”，页 24)。

充电电池型号GBA 18V...



LED指示灯	电量
3个绿灯常亮	60-100 %
2个绿灯常亮	30-60 %
1个绿灯常亮	5-30 %
1个绿灯闪烁	0-5 %

充电电池型号ProCORE18V...



LED指示灯	电量
5个绿灯常亮	80-100 %
4个绿灯常亮	60-80 %
3个绿灯常亮	40-60 %
2个绿灯常亮	20-40 %
1个绿灯常亮	5-20 %
1个绿灯闪烁	0-5 %

安装保护装置

- ▶ 在电动工具上进行任何维护的工作（例如维修，更换工具等等），以及搬运、保存电动工具之前都必须从机器中取出蓄电池。无意间操作开关可能会造成伤害。

提示：使用过程中砂轮片断裂或防护罩/电动工具上的固定装置损坏后，必须立即将电动工具寄给客户

服务部门，地址参见章节“客户服务和应用咨询”。

研磨防护罩

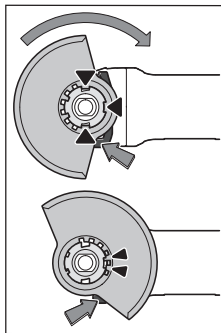

将防护罩(10)放到电动工具的支座上，直至防护罩的编码凸轮与支座重合。按压并按住解锁杆(1)。将防护罩(10)压到主轴颈上，直至防护罩的凸肩套在电动工具的法兰上，然后转动防护罩，直至能够清楚地听见卡止声。根据工作需要调整好防护罩(10)的位置。为此朝上推动解锁杆(1)，然后将防护罩(10)转到所需位置。

- ▶ 不断调整防护罩(10)，使解锁杆(1)的两个凸轮卡入防护罩(10)相应的开口中。
- ▶ 调整防护罩(10)，以防有火花朝操作人员方向飞溅。
- ▶ 唯有通过操纵解锁开关(1)才能使防护罩(10)转动！否则，在任何条件下都不得继续使用电动工具，必须将其交给客户服务部门。

提示：防护罩(10)上的编码凸轮确保只能安装一个与电动工具匹配的防护罩。

切割防护罩

- ▶ 使用合成磨料切割时，必须使用切割专用防护罩(15)。
- ▶ 切割石材时必须进行足够的集尘。

切割防护罩(15)与研磨防护罩(10)的安装方法一样。

辅助手柄

- ▶ 操作电动工具时务必使用辅助手柄(9)。
- 视操作方法而定，在机头左侧或右侧旋入辅助手柄(9)。

具备减震功能的辅助手柄



具备减震功能的辅助手柄不仅能够降低工作时的震动，更可以提高操作机器的舒适性和确保

工作安全。

- ▶ 切勿在辅助手柄上做任何修改。
- 请勿继续使用已经损坏的辅助手柄。

护手

- ▶ 使用橡胶磨盘(20)或杯型钢丝刷/轮刷/千叶砂磨轮操作时，请务必安装护手(19)。
- 用辅助手柄(9)固定护手(19)。

安装磨具

- ▶ 在电动工具上进行任何维护的工作（例如维修，更换工具等等），以及搬运、保存电动工具之前都必须从机器中取出蓄电池。无意间操作开关可能会造成伤害。

- ▶ 在磨片和切割片尚未冷却之前，切勿抓取。工作时砂轮会变得非常炙热。

清洁研磨主轴(18)和所有待安装的零件。

夹紧及松开磨具时，请按压主轴锁定键(3)以固定研磨主轴。

- ▶ 待主轴完全静止后，才可以操纵主轴锁定键。否则可能会损坏电动工具。

砂轮/切割片

注意磨具的规格。孔径必须和固定法兰完全吻合。

请勿使用转接件或异径管。

使用金刚石切割片时，金刚石切割片上的箭头方向必须和机器的旋转方向一致（参考机头上的旋转方向箭头）。

安装过程请参考插图页。

拧入夹紧螺母(13)以固定砂轮/切割片，然后使用双锁扳手拧紧螺母。

- ▶ 在安装好磨具且尚未开动磨机之前，必须检查磨具是否正确安装，磨具能否自由无阻地旋转。务必确保磨具转动时不会和防护罩或其他机件产生摩擦。

千叶砂磨轮

- ▶ 使用千叶砂磨轮操作时，请务必安装护手(19)。

橡胶磨盘

- ▶ 使用橡胶磨盘(20)操作时，请务必安装护手(19)。

安装过程请参考插图页。

将橡胶磨盘(20)推到研磨主轴(18)上。

将砂纸(21)牢固地按压到橡胶磨盘(20)的底部。

拧上圆形螺母(22)，然后用双锁扳手拧紧。

杯形钢丝刷/轮刷

- ▶ 使用杯形钢丝刷/轮刷操作时，请务必安装护手(19)。

安装过程请参考插图页。

将杯形钢丝刷/轮刷尽量拧入磨削主轴中，使得能紧靠在磨削主轴螺纹末端的法兰上。使用开口扳手拧紧杯形钢丝刷/轮刷。

硬质合金杯形砂轮

- ▶ 仅允许在装有合适的防护罩的情况下使用杯形砂轮。





允许使用的磨具

您可以使用本说明书中提到的所有磨具。

所用磨具的许可转速[转/分钟]或圆周转速[米/秒]必须和以下表格中的数据一致。

因此，请遵守磨具标签上所允许的转速或圆周速度。

	最大[毫米]	[毫米]		
	D	b	d	[转/分钟] [米/秒]
	100	7	16	11000 80

	最大[毫米]	[毫米]		
	D	b	d	[转/分钟] [米/秒]
	100	-	-	11000 80
	75	30	M 14	11000 45
	82	-	M 14	11000 80

转动机头 (GWS 18V-15 C)

- ▶ 在电动工具上进行任何维护的工作（例如维修、更换工具等等），以及搬运、保存电动工具之前都必须从机器中取出蓄电池。无意间操作开关可能会造成伤害。

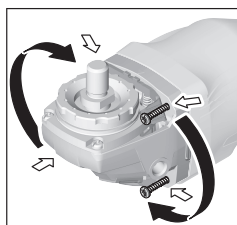

可将机头旋转90度。这样就能在特殊工作状况下将电源开关置于比较容易操作的位置，例如针对左撇子。

将4个螺丝完全拧出。将机头小心地转入新位置，而无需从壳体上取下。重新拧紧4个螺丝。

吸锯尘/吸锯屑

含铅的颜料以及某些木材、矿物和金属的加工废尘有害健康。机器操作者或者工地附近的人如果接触、吸入这些废尘，可能会有过敏反应或者感染呼吸道疾病。

某些尘埃（例如加工橡木或山毛榉的废尘）可能致癌，特别是和处理木材的添加剂（例如木材的防腐剂等）结合之后。只有经过专业训练的人才能够加工含石棉的物料。

- 工作场所要保持空气流通。

- 最好佩戴P2滤网等级的口罩。

请留心并遵守贵国和加工物料有关的法规。

- ▶ 避免让工作场所堆积过多的尘垢。尘埃容易被点燃。

运行

投入使用

安装充电电池

将充好电的充电电池(7)从前部推入电动工具脚座中，直至充电电池牢牢锁定。

接通/关闭

如要**运行**电动工具，请将电源开关(5)向前推。

如要**锁定**电源开关(5)，请向前按下电源开关(5)直至卡止。

如要**关闭**电动工具，请松开电源开关(5)，或当电源开关卡止时短促向后按下电源开关(5)，然后松开。

► **使用前，请先检查磨具。必须正确安装磨具，使其可以自由转动。进行至少1分钟的无负载试机。切勿使用损坏、变形或转动时会振动的磨具。损坏的磨具可能断裂并造成伤害。**

回弹断开

当电动工具突然回弹时（比如切割边卡住），将以电子方式中断电机供电。同时，回弹断开指示灯(26)亮起。在回弹断开功能激活后，状态指示灯(30)闪红光。

转速预选 (GWS 18V-15 SC)

出厂设置中已预设3个转速等级。通过特殊的应用程序（Bosch Toolbox 应用程序）可以编程最多6个转速等级。

如需更改转速等级的数量，则调整每个等级的预设数值。在这种情况下，转速等级/模式指示灯(28)亮白光。如需个性化编程转速值，则转速等级/模式指示灯(28)在该转速等级时亮蓝光（即不符合基本设置）。转速等级可以个性化调整为每200转每分的步进。对此请注意等级的上升逻辑（ $2 \geq 1 / 3 \geq 2$ ，以此类推）。

以下表格显示每个已编程等级数量的预设转速（基本设置）。

GWS 18V-15 SC	等级的转速基本设置					
	1	2	3	4	5	6
	[转/分钟]	[转/分钟]	[转/分钟]	[转/分钟]	[转/分钟]	[转/分钟]
转速等级数量						
1	3400	-	-	-	-	-
2	3400	9800	-	-	-	-
3	3400	6600	9800	-	-	-
4	3400	5600	7600	9800	-	-
5	3400	5000	6600	8200	9800	-
6	3400	4600	6000	7200	8600	9800

给出的转速等级数值与所使用的充电电池、充电量以及设备的工作温度有关。

利用转速预选按钮(27)也可以在运行过程中预选所需的转速。以下表格中的数据只供带3个预设转速等级的出厂设置作参考。

工件材料	用途	切削附件	转速预选等级	GWS 18V-15 SC [转/分钟]
金属	刷磨，除锈	杯形钢丝刷	1	3400
不锈钢	研磨	纤维垫圈	2	6600
金属	粗磨	砂轮	3	最大
金属	切割	砂轮	3	最大
石材	切割	金刚石切割片和引导滑座（仅允许在搭配引导滑座的情况下切割岩石）	3	最大

► **附件的额定速度必须至少等于电动工具上标出的最大速度。**附件以比其额定速度大的速度运转会发生爆裂和飞溅。

如需**再次使用**，请将电源开关(5)置于关闭位置，然后重新接通电动工具。

重启保护

重启保护功能可以避免电动工具在供电中断之后突然失控地重新启动。

重启保护功能激活后，状态指示灯(30)闪红光。

如需**再次使用**，请将电源开关(5)置于关闭位置，然后重新接通电动工具。

撞击断开

一旦撞击到地面，内置的撞击断开功能就会关闭电动工具。同时，状态指示灯(30)闪红光。

如需**再次使用**，请将电源开关(5)置于关闭位置，然后重新接通电动工具。

用户界面（参见插图A）

用户界面(4)用于预选转速和显示电动工具的状态。

状态指示灯

充电电池电量指示灯 (用户界面) (25)	含义/原因	解决方案
绿色	充电电池已充电	-
黄色	充电电池的电量几乎耗尽	尽快更换充电电池或为其充电
红色	充电电池的电量用尽了	更换充电电池或为其充电

温度显示(31)	含义/原因	解决方案
黄色	已达到临界温度 (电机、电子系统、充电电池)	让电动工具空转、冷却
红色	电动工具过热并关闭	让电动工具冷却

电动工具状态指示灯(30)	含义/原因	解决方案
绿色	状态正常	-
黄色	已达到临界温度或充电电池的电量几乎耗尽	让电动工具空转、冷却或尽快更换充电电池或为其充电
亮红光	电动工具过热或充电电池电量耗尽	让电动工具冷却或更换充电电池或为其充电
闪红光	触发了回弹断开功能、重启保护功能或撞击断开功能	关闭并再次接通电动工具
闪蓝光	电动工具已与移动终端设备连接或正在传输设置	-

连接功能

搭配 *Bluetooth*® (蓝牙) Low Energy Module (低能耗模块) **GCY 42**, 为电动工具提供以下连接功能:

- 注册和个性化设置
- 状态检查, 警告信息输出
- 通用信息和设置
- 管理

有关 *蓝牙*® Low Energy Module (低能耗模块)

GCY 42 的信息请见相应的使用说明。

电动工具与应用程序的连接必须通过按压用户界面 **(4)** 上的转速预选 **(27)** 键进行确认。应用程序在连接时将发送该请求。

工作提示

- ▶ 装入了 *Bluetooth*® (蓝牙) 低能耗模块 **GCY 42** 的电动工具配有一个无线接口。必须注意本地运行限制, 例如在飞机上或医院里。
- ▶ 在不允许使用 *Bluetooth*® (蓝牙) 无线技术的区域内, 必须取出 *蓝牙*® 低能耗模块 **GCY 42** 和纽扣电池。
- ▶ 在支撑墙上开缝时必须特别小心, 参考段落“有关静力学的注意事项”。
- ▶ 固定好站立不稳的工件。
- ▶ 勿让电动工具因为过载而停止转动。
- ▶ 强烈过载之后必须让电动工具在无载的状况下运转数分钟, 这样能够帮助电动工具冷却。
- ▶ 不要将电动工具安装在切割研磨架上使用。

▶ 在磨片和切割片尚未冷却之前, 切勿抓取。工作时砂轮会变得非常炙热。

如果电动工具产生静电充电, 电子装备会自动关闭电动工具。重新按压电源开关 **(5)**, 以再次运行电动工具。

粗磨

▶ 不要使用切割片进行粗磨。

粗磨时如果砂轮和研磨表面成30至40度角, 能实现最好的工作效果。操作时只需轻压并来回移动电动工具, 这样工件不会变热、变色, 也不会出现凹陷的痕迹。

千叶砂磨轮

使用千叶砂磨轮 (附件) 可以在隆起的表面和型材上研磨。

千叶砂磨轮的使用寿命比一般砂轮的使用寿命长, 而且工作噪音和研磨温度也比较低。

切割金属

▶ 使用合成磨料切割时, 必须使用切割专用防护罩 **(15)**。

切割时必须施力均匀, 根据要加工的材料决定推动的力道。请勿对切割片施加压力, 请勿倾斜和摇晃。

请勿通过侧压的方式来制动仍然继续转动的切割片。

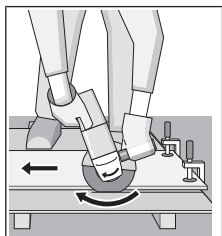

必须逆着切割片的转向推动电动工具，否则容易失控，导致电动工具从切线中滑出。

切割型材和方管时最好使用最小的截面。

切割石材

- ▶ 切割石材时必须进行足够的集尘。
- ▶ 请佩戴防尘面具。
- ▶ 本电动工具只能进行干式切割/干式磨削。

切割石材时最好使用金刚石切割片。

切割高硬度的工件时，例如碎石含量很高的水泥，可能因为金刚石切割片过热而导致切割片损坏。金刚石切割片的周围会出现明显的火花。

在这种情况下应暂停切割过程，让金刚石切割片在空载的状况下以最高转速旋转片刻，以便冷却。

如果工作进度明显降低而且出现火花环，则表示金刚石切割片已经变钝。此时可以将切割片在研磨材料（例如石灰砂石）上来回刷磨数次，重新磨利切割片。

有关静力学的提示

关于在支撑墙上开缝时应该注意的事项，请参考 DIN 1053 第一部的规定或各国有关的法规。务必遵守相关的法律规定。开始工作之前，先向负责的静力学专家、工程师或工程负责人请教有关细节。

有关以最佳方式使用充电电池的提示

保护充电电池，避免湿气和水分渗入。

充电电池必须储存在 -20 °C 至 50 °C 的环境中。夏天不得将充电电池搁置在汽车中。

不定时地使用柔软、清洁而且干燥的毛刷清洁充电电池的通气孔。

充电后如果充电电池的使用时间明显缩短，代表充电电池已经损坏，必须更换新的充电电池。

请注意有关废弃处理的规定。

维修和服务

保养和清洁

- ▶ 在电动工具上进行任何维护的工作（例如维修，更换工具等等），以及搬运、保存电动工具之前都必须从机器中取出蓄电池。无意间操作开关可能会造成伤害。
- ▶ 电动工具和通气孔必须随时保持清洁，以确保工作效率和工作安全。

小心地保存和使用附件。

客户服务和应用咨询

本公司顾客服务处负责回答有关本公司产品的修理、维护和备件的问题。备件的展开图纸和信息也可查看：www.bosch-pt.com

博世应用咨询团队乐于就我们的产品及其附件问题提供帮助。

询问和订购备件时，务必提供机器铭牌上标出的10位数物品代码。

中国大陆

博世电动工具（中国）有限公司
中国 浙江省 杭州市
滨江区 滨康路567号
102/1F 服务中心
邮政编码：310052
电话：(0571)8887 5566 / 5588
传真：(0571)8887 6688 x 5566# / 5588#
电邮：bsc.hz@cn.bosch.com
www.bosch-pt.com.cn

制造商地址：

Robert Bosch Power Tools GmbH
罗伯特·博世电动工具有限公司
70538 Stuttgart / GERMANY
70538 斯图加特 / 德国

其他服务地址请见：

www.bosch-pt.com/serviceaddresses

搬运

随着机器一起供货的锂离子充电电池必须符合危险物品法规。使用者无须另外使用保护包装便可以运送该充电电池。

但是如果将它交由第三者运送（例如：寄空运或委托运输公司）则要使用特殊的包装和标示。此时必须向危险物品专家请教有关寄送危险物品的相关事宜。

确定充电电池的外壳未受损后，才可以寄送充电电池。粘好未加盖的触点并包装好充电电池，不可以让充电电池在包装中晃动。必要时也得注意各国有关的法规。

处理废弃物



必须以符合环保的方式，回收再利用损坏的电动工具、充电电池、附件和废弃的包装材料。



不可以把电动工具和充电电池/蓄电池丢入一般的家庭垃圾中！

充电电池/电池：

锂离子：

请注意“搬运”段落中的指示（参见“搬运”，页 25）确认设置。

CMIIT ID显示在蓝牙设备铭牌上

繁體中文

安全注意事項

電動工具通用安全警告

警告 閱讀所有警告和所有說明。不遵照以下警告和說明會導致電擊、著火和/或嚴重傷害。

保存所有警告和說明書以備查閱。

在所有警告中，「電動工具」此一名詞泛指：以市電驅動的（有線）電動工具或是以電池驅動的（無線）電動工具。

工作場地的安全

- ▶ 保持工作場地清潔和明亮。雜亂和黑暗的場地會引發事故。
- ▶ 不要在易爆環境，如有易燃液體、氣體或粉塵的環境下操作電動工具。電動工具產生的火花會點燃粉塵或氣體。
- ▶ 讓兒童和旁觀者離開後操作電動工具。注意力不集中會使您失去對工具的控制。

電氣安全

- ▶ 電動工具插頭必須與插座相配。絕不能以任何方式改裝插頭。需接地的電動工具不能使用任何轉換插頭。未經改裝的插頭和相配的插座將減少電擊危險。
- ▶ 避免人體接觸接地表面，如管道、散熱片和冰箱。如果您身體接地會增加電擊危險。
- ▶ 不得將電動工具暴露在雨中或潮濕環境中。水進入電動工具將增加電擊危險。
- ▶ 不得濫用電線。絕不能用電線搬運、拉動電動工具或拔出其插頭。將電線遠離熱源、油、銳利邊緣或移動零件。受損或纏繞的軟線會增加電擊危險。
- ▶ 當在戶外使用電動工具時，使用適合戶外使用的延長線。適合戶外使用的軟線，將減少電擊危險。
- ▶ 如果在潮濕環境下操作電動工具是不可避免的，應使用剩餘電流動作保護器（RCD）。使用RCD可降低電擊危險。

人身安全

- ▶ 保持警覺，當操作電動工具時關注所從事的操作並保持清醒。當您感到疲倦，或在有藥物、酒精或治療反應時，不要操作電動工具。在操作電動工具時瞬間的疏忽會導致嚴重人身傷害。
- ▶ 使用個人防護裝置。務必佩戴護目鏡。安全裝置，諸如適當條件下使用防塵面具、防滑安全鞋、安全帽、聽力防護等裝置能減少人身傷害。
- ▶ 防止意外起動。確保開關在連接電源和/或電池組、拿起或搬運工具時處於關閉位置。手指放在已接通電源的開關上或開關處於接通時插入插頭可能會導致危險。

- ▶ 在電動工具接通之前，拿掉所有調節鑰匙或扳手。遺留在電動工具旋轉零件上的扳手或鑰匙會導致人身傷害。
- ▶ 手不要伸展得太長。時刻注意立足點和身體平衡。這樣在意外情況下能很好地控制電動工具。
- ▶ 著裝適當。不要穿著寬鬆衣服或佩戴飾品。衣服、手套和頭髮請遠離移動零件。寬鬆衣服、佩飾或長髮可能會捲入移動零件中。
- ▶ 如果有排屑、集塵設備連接用的裝置，請確保其連接完好且使用得當。使用這些裝置可減少塵屑引起的危險。

電動工具使用和注意事項

- ▶ 請勿濫用電動工具，根據用途使用適當的電動工具。選用適當設計的電動工具會使您工作更有效、更安全。
- ▶ 如果開關不能開啟或關閉工具電源，則不能使用該電動工具。不能用開關來控制的電動工具是危險的且必須進行修理。
- ▶ 在進行任何調整、更換附件或貯存電動工具之前，必須從電源上拔掉插頭和/或將電池組拆下。這種防護性措施將減少工具意外起動的危險。
- ▶ 將閒置不用的電動工具貯存在兒童所及範圍之外，不得讓不熟悉電動工具或對這些說明不瞭解的人操作電動工具。由未經訓練的人員使用電動工具相當危險。
- ▶ 保養電動工具。檢查移動零件是否調整到位或卡住，檢查零件破損情況和影響電動工具運轉的其他狀況。如有損壞，電動工具應在使用前修理完成。許多事故由維護不良的電動工具引發。
- ▶ 保持切削刀具鋒利和清潔。保養良好的有鋒利切削刃的刀具不易卡住而且容易控制。
- ▶ 按照使用說明書，考慮作業條件和進行的作業來使用電動工具、配件和工具的尖端等。將電動工具用於那些與其用途不符的操作可能會導致危險。

電池式工具使用和注意事項

- ▶ 只用製造商規定的充電器充電。將適用於某種電池組的充電器用到其他電池組時會發生著火危險。
- ▶ 只有在配有專用電池組的情況下才使用電動工具。使用其他電池組會發生損壞和著火危險。
- ▶ 當電池組不用時，請遠離其他金屬物體，例如迴紋針、硬幣、鑰匙、釘子、螺絲或其他小金屬物體，以防一端與另一端連接。電池接點短路會引起燃燒或火災。
- ▶ 在誤用的情況下，液體會從電池中濺出；請避免接觸。如果意外接觸，應立刻用水沖洗。如果液體碰到了眼睛，務必就醫。從電池中濺出的液體會發生腐蝕或燃燒。

檢修

- ▶ 將您的電動工具送交專業維修人員，必須使用同樣的備件進行更換。這樣將確保所維修的電動工具的安全性。

針對角磨機的安全規章

研磨、砂磨、鋼絲刷或砂輪切割作業的一般安全警告

- ▶ **本電動工具可作為砂輪機、砂磨機、鋼絲刷或切割工具。請詳讀電動工具隨附的所有安全警告、指示、插圖以及規格等資料。若不遵照以下列出的指示，將可能導致電擊、著火和/或人員重傷。**
- ▶ **不建議以此電動工具進行諸如打蠟等項作業。使用本電動工具進行非設計用途的作業將產生危險並導致人員受傷。**
- ▶ **請勿使用非針對本工具設計的配件或非工具製造商建議使用的配件。即使該配件可安裝至電動工具上，並不代表可以安全地操作電動工具。**
- ▶ **配件的額定速率必須至少等於電動工具上所標示的最大速率。配件的運轉速度若高於其額定速率，可能會造成其破損並解體。**
- ▶ **配件的外徑及厚度必須在電動工具的額定功率範圍內。規格不正確的配件無法讓防護機制發揮應有功能，或者可能失控。**
- ▶ **配件的螺紋部位必須符合砂輪機的主軸螺紋。如果是利用凸緣安裝的配件，則配件的軸孔必須符合凸緣位置的直徑。配件若無法完全符合電動工具的安裝硬體，那麼運轉時將造成失衡、震動幅度過大，甚至造成失控。**
- ▶ **不可使用已受損的配件。每次使用前請檢查配件，確認研磨砂輪片是否有缺口和裂縫、托盤是否有裂縫、撕裂或過度磨損的現象、鋼絲刷是否發生鬆脫或鋼絲缺損的狀況。電動工具或配件萬一掉落，請檢查是否受損或直接換裝完好的配件。檢查並安裝好配件之後，請您與旁觀者遠離配件的旋轉平面，接著讓電動工具以最高空載速度，持續運轉一分鐘。配件若有受損，通常會在此測試期間分解。**
- ▶ **請穿戴個人防護裝備。根據實際操作狀況，使用面罩、安全護目鏡或防護眼鏡。在適當情況下，請戴上防塵面罩、聽力防護裝置、手套以及可防止細小磨料或工件碎片的工作圍裙。護目裝置必須能有效阻擋各種操作中所產生的噴飛碎屑。防塵面罩或口罩必須能過濾操作中所產生的粉塵。暴露在高分貝噪音中過久，會造成聽力受損。**
- ▶ **請旁觀者與工作區保持安全距離。進入工作區的所有人員都必須穿戴個人防護裝備。工件碎片或破損的配件可能會四處噴飛，造成作業區範圍以外的附近人員受傷。**
- ▶ **進行作業時，負責進行切割的配件可能會碰觸到隱藏的配線，請務必從絕緣處握持處拿持電動工具。負責進行切割的配件若是觸及「導電」電線，可能導致電動工具外露的金屬部件「導電」，進而使操作人員遭受電擊。**
- ▶ **在配件完全靜止之前，請勿放下電動工具。旋轉中的配件可能會扣住放置表面，電動工具因為被拉扯而失控。**
- ▶ **當您將電動工具握在身體側邊時，請勿讓它運轉。萬一不小心碰觸到旋轉中的配件，衣物可能會被撕裂並將配件導向自己的身體。**

- ▶ **請定期清理電動工具的通風口。馬達風扇會將粉塵捲入機殼內，累積過多的金屬粉塵可能危及電氣安全。**
- ▶ **請勿在易燃材料旁操作本電動工具。火花可能引燃這些易燃物。**
- ▶ **請勿使用需要冷卻液的配件。使用水或其他冷卻液可能導致觸電或電擊事件。**

反彈與相關警告

反彈是旋轉中之砂輪、底盤、鐵刷或任何其他配件卡住或斷裂時瞬間產生的反作用力。旋轉中的配件發生卡住或斷裂時會突然停止轉動，這將從連接位置造成電動工具失控並以配件旋轉相反的方向運轉。

舉例來說，工件如果造成研磨砂輪片斷裂或卡住，已推入卡住位置的砂輪邊緣可能會鑽進材料表面裡，而使砂輪脫出或反彈。依據砂輪卡住時的移動方向，它有可能彈向或跳離操作人員。在上述情況下，研磨砂輪片亦可能斷裂。

反彈是不當使用電動工具及/或操作程序（條件）不正確所造成的結果。採取以下適當預防措施，則可避免此一情況。

- ▶ **緊掌握好電動工具，並穩住您的雙臂和身體，以抵抗反彈力道。務必使用輔助握把（若有配備），以求有效掌控啟動時的反彈或扭力。操作人員只要採取適當防護措施，即可控制扭矩的反作用力以及反彈力道。**
- ▶ **雙手請勿靠近旋轉中的配件。配件可能會反彈並擊中您的手。**
- ▶ **請勿將身體任何部位放置在發生反彈時電動工具位移的範圍之內。斷裂時，反彈力道會將本工具推向砂輪移動的相反方向。**
- ▶ **處理尖角、銳利邊緣等物時，請穿戴特殊的防護裝備，防範配件彈跳和斷裂。尖角、銳利邊緣或彈跳力道往往會扯斷旋轉中的配件，並造成工具失控或反彈。**
- ▶ **請勿加裝鏈鋸型木雕鋸片或鋸齒型鋸片。此類刀片會產生規律性反彈，進而導致本工具失控。**

研磨及研磨切割操作的安全警告

- ▶ **僅可使用電動工具建議的砂輪類型，以及專為選用之砂輪而設計的特定防護套。使用非專為電動工具設計的砂輪，防護機制將無法發揮應有功能，亦無法確保安全。**
- ▶ **中心凹陷的砂輪其研磨表面必須安裝在防護套緣的下方。如果安裝不當而導致砂輪突出於防護套緣時，將無法提供應有的保護。**
- ▶ **防護套須確實固定於電動工具上，且位於最安全位置，以確保砂輪只有最小部分外露於操作人員面前。防護套可保護操作人員，以免被已損壞之砂輪的碎片擊傷、意外碰觸砂輪，或是被火花引燃衣物的危險。**
- ▶ **砂輪僅可用於建議用途。例如：勿以切割砂輪的兩側進行研磨。切割砂輪係專為周邊研磨而設計。對砂輪側面施力，可能會使其解體。**
- ▶ **所使用的砂輪凸緣必須完好無損並符合選用之砂輪的規格及形狀。合適的砂輪凸緣可支撐砂輪，**

進而降低砂輪破裂的風險。切割砂輪的凸緣可能與研磨砂輪的凸緣不同。

- ▶ **請勿使用大型電動工具磨耗後的砂輪。**大型電動工具使用的砂輪並不適合用於高速運轉的小型工具，可能會造成砂輪碎裂。

研磨切割作業的其他安全警告

- ▶ **切割砂輪不可「卡死」或對其施力過大。不可作太深的切割。**對砂輪施力過大時會增加負載，容易造成切割時砂輪扭曲變形或卡死不動，並且增加發生反彈或砂輪破損的可能性。
- ▶ **您所處的位置不可與旋轉中的砂輪呈一直線，亦不可站在其後。**砂輪運轉時其方向若是轉離您的身體，萬一發生反彈時，會將旋轉中的砂輪與電動工具直接推向您。
- ▶ **當砂輪因任何原因卡死不動或中斷切割時，請關閉本電動工具，然後握住它不要移動，直至砂輪完全停止轉動。請勿嘗試在切割砂輪仍運轉時將它移出切口，否則可能引發反彈。**瞭解情況並採取更正措施，以消除砂輪卡死的原因。
- ▶ **請勿於工件內部重新開始切割作業。請讓砂輪全速轉動，並小心重新進入切口。**若是在工件內部重新開始運轉電動工具，砂輪可能會卡死不動、往上滑移或發生反彈。
- ▶ **支撐控制板或超大尺寸的工件可降低砂輪卡住及發生反彈的風險。**大型工件可能因其本身的重量而下垂。必須在工件下方、靠近切割線及靠近工件邊緣的砂輪兩側加以支撐。
- ▶ **在牆面上或其他盲蔽區域進行開孔切割時，請格外小心。**突出的砂輪可能會切斷瓦斯管或水管、電線或任何物件，繼而造成反彈。

砂磨作業的安全警告

- ▶ **所使用的砂紙尺寸不得超出原本尺寸過多。**選用砂紙時，請遵循製造商建議。砂紙若超出砂紙碟的尺寸，則存在撕裂風險，並且可能造成磨片斷裂、撕裂或發生反彈。

鋼絲刷磨作業的安全警告

- ▶ **即使是執行一般作業，也請小心刷子可能會甩出鋼絲。**刷子超載時請勿對鐵刷施力過大。鋼絲可以輕易的刺穿輕薄衣物和/或皮膚。
- ▶ **建議您在鋼絲刷磨時應使用防護套，但需注意不得因防護套而干擾鋼絲輪或鐵刷的運作。**鋼絲輪或鐵刷使用一段時間後，並在離心力的影響之下，其直徑可能會變寬。

其他安全注意事項

請佩戴護目鏡。



- ▶ **使用合適的偵測裝置偵察隱藏的電線，或者向當地的相關單位尋求支援。**接觸電線可能引起火災並讓操作者觸電。若損壞瓦斯管會引起爆炸。如果水管被刺穿會導致財物損失。
- ▶ **在研磨/割片尚未冷卻之前，切勿持握研磨/割片。**作業時，切割片會變得非常炙熱。

- ▶ **如果電源突然中斷，例如取出充電電池時，必須馬上解除電源開關的鎖定，並把它設在關閉位置。**這樣可以避免機器突然再起動而造成失控。
- ▶ **固定好工件。**使用固定裝置或老虎鉗固定工件，會比用手持握工件更牢固。
- ▶ **如果充電電池損壞了，或者未按照規定使用充電電池，充電電池中會散發出有毒蒸氣。充電電池可能起火或爆炸。**工作場所必須保持空氣流通，如果身體有任何不適必須馬上就醫。充電電池散發的蒸氣會刺激呼吸道。
- ▶ **切勿拆開充電電池。**可能造成短路。
- ▶ **尖銳物品（例如釘子或螺絲起子）或是外力皆有可能造成充電電池損壞。**進而導致內部短路而發生電池起火、冒煙、爆炸或過熱等事故。
- ▶ **僅可使用產品的原廠充電電池。**如此才可依照產品提供過載保護。



保護充電電池免受高溫（例如長期日照）、火焰、污垢、水液和濕氣的侵害。有爆炸及短路之虞。



- ▶ **小心！使用電動工具時若開啟 Bluetooth® 功能，將可能對其他裝置或設備、飛機以及醫療器材（例如心律調節器、助聽器等）產生干擾。**同樣亦無法完全排除對鄰近之人員或動物造成身體危害的可能性。請勿在醫療器材、加油站、化學設備、爆炸危險場所以及易爆環境等處附近，使用電動工具的 Bluetooth® 功能。請勿在飛機上使用電動工具的 Bluetooth® 功能。應避免直接貼靠在身體部位旁的長時間持續操作。

Bluetooth® 一詞及其標誌（商標）為 Bluetooth SIG, Inc. 所擁有之註冊商標。Robert Bosch Power Tools GmbH 對於此詞彙/標誌之任何使用均已取得授權。

產品和規格



請詳讀所有安全注意事項和指示。如未遵守安全注意事項與指示，可能導致火災、人員遭受電擊及/或重傷。
請留意操作說明書中最前面的圖示。

依規定使用機器

本電動工具適合在金屬和石材上進行切割、粗磨以及刷磨。操作機器時不需要用水沖刷。

使用結合式研磨器具進行切割時，必須安裝特殊的切割專用防護罩。

在石材上進行切割時，必須安裝合適的吸塵裝置。裝上適用的磨具後，也可以使用本電動工具進行砂紙研磨。

電動工具若有搭載 Bluetooth® Low Energy Module **GCY 42**，即可透過 Bluetooth® 無線技術，與終端行動裝置傳輸資料和設定。

插圖上的機件

機件的編號和電動工具詳解圖上的編號一致。

(1) 防護罩的解扣桿

- | | |
|--------------------------------------|---------------------------|
| (2) 機殼上的旋轉方向指示箭頭 | (18) 磨削主軸 |
| (3) 主軸鎖止按鈕 | (19) 護手板 ^{A)} |
| (4) 使用者介面 | (20) 橡膠磨盤 ^{A)} |
| (5) 起停開關 | (21) 研磨片 ^{A)} |
| (6) 藍牙® Low Energy Module GCY 42 的護蓋 | (22) 圓螺母 ^{A)} |
| (7) 充電電池 ^{A)} | (23) 杯形鋼絲刷 ^{A)} |
| (8) 充電電池解鎖按鈕 ^{A)} | (24) 鑽石開孔鑽頭 ^{A)} |
| (9) 輔助手柄 (絕緣握柄) | (25) 充電電池的電量指示器 (使用者介面) |
| (10) 研磨專用防護罩 | (26) 反彈斷電功能指示器 (使用者介面) |
| (11) 具有 O 形環的配接法蘭 | (27) 轉速預設按鈕 (使用者介面) |
| (12) 研磨砂輪 | (28) 轉速檔位/模式指示器 (使用者介面) |
| (13) 迫緊螺母 | (29) 智慧型手機指示器 (使用者介面) |
| (14) 硬金屬杯形磨盤 ^{A)} | (30) 電動工具狀態指示器 (使用者介面) |
| (15) 切割專用防護罩 ^{A)} | (31) 溫度指示器 (使用者介面) |
| (16) 切割砂輪 ^{A)} | (32) 千葉研磨砂輪 ^{A)} |
| (17) 把手 (絕緣握柄) | |

A) 圖表或說明上提到的配件，並不包含在基本的供貨範圍中。本公司的配件清單中有完整的配件供應項目。

技術性數據

砂輪機		GWS 18V-15 C	GWS 18V-15 SC
產品機號		3 601 JH6 0..	3 601 JH6 1..
額定電壓	V=	18	18
額定轉速 ^{A)}	次 / 分	11000	11000
無負載轉速 ^{B)}	次 / 分	9800	3400-9800
研磨砂輪最大直徑	mm	100	100
磨削主軸螺紋		M 10	M 10
磨削主軸上的最大螺紋長度	mm	16	16
反彈斷電功能		●	●
防止再起動功能		●	●
制止慣性轉動功能		●	●
轉速設定		-	●
重量符合 EPTA-Procedure 01:2014 ^{C)}			
- 具有減震功效的輔助手柄	kg	2.5-3.5	2.5-3.5
- 使用標準型輔助手柄	kg	2.3-3.3	2.3-3.3
充電狀態下的建議環境溫度	°C	0 ... +35	0 ... +35
操作狀態下的容許環境溫度 ^{D)} 以及存放狀態下	°C	-20 ... +50	-20 ... +50
相容的充電電池		GBA 18V... ProCORE18V...	GBA 18V... ProCORE18V...
為確保最大效能而建議使用的充電電池		ProCORE18V...≥ 5.5 Ah	ProCORE18V...≥ 5.5 Ah
建議使用的充電器		GAL 18... GAX 18... GAL 36...	GAL 18... GAX 18... GAL 36...
資料傳輸			
藍牙®		藍牙 4.2 (低功率) ^{E)}	藍牙 4.2 (低功率) ^{E)}
訊號間隔時間	秒	8	8

砂輪機	GWS 18V-15 C	GWS 18V-15 SC
訊號最遠傳送範圍 ^{F)}	m	30

- A) 額定轉速係依據規範 EN 60745-2-3
 B) 於 20–25 °C 配備充電式 ProCORE18V 8.0Ah 時測得，並需視充電電池的電量和裝置的操作溫度而定
 C) 視所使用的充電蓄電池而定
 D) 溫度 <0 °C 時，性能受限
 E) 終端行動裝置必須與 Bluetooth® (藍牙) 低功耗設備 (4.2 版) 相容，並支援 Generic Access Profile (GAP)。
 F) 此傳送範圍受外在環境條件 (包含您所使用之接收裝置) 的影響而有極大差異。在密閉空間內，諸如牆面、置物櫃、提箱等物品中的金屬部件會阻礙藍牙® 功能的傳輸，而使訊號傳送範圍明顯縮小。

安裝

安裝 藍牙® Low Energy Module GCY 42

提示：若是 GWS 18V-15 C 電動工具，藍牙® Low Energy Module GCY 42 做為配件，需另外選購；若是 GWS 18V-15 SC 電動工具，則已包含在供貨範圍內。

如需 Bluetooth® Low Energy Module **GCY 42** 的相關資訊，請詳讀其操作說明書。

為充電電池進行充電

▶ **只能選用技術性數據裡所列出的充電器。**僅有這些充電器適用於電動工具所使用的鋰離子充電電池。

提示：出貨時充電電池已部分充電。首度使用電動工具之前，請先用充電器將充電電池充飽電以確保充電電池蓄滿電力。

鋰離子充電電池可隨時充電，不會縮短電池的使用壽命。如果突然中斷充電，電池也不會損壞。

鋰離子充電電池配備了電池保護裝置「Electronic Cell Protection (ECP)」，可以防止充電電池過度放電。充電電池的電量如果用盡了，保護開關會自動關閉電動工具；嵌件工具會停止轉動。

▶ **電動工具自動關機後，請勿再按壓電源開關。**否則充電電池可能會損壞。

請您遵照廢棄物處理相關指示。



取出充電電池

本充電電池 (7) 具備了雙重鎖定功能，即使不小心按壓了充電電池解鎖按鈕 (8)，充電電池也不會從機器中掉落出來。固定彈簧會把充電電池夾緊在機器中。

若要取出充電電池 (7)，請按壓解鎖按鈕 (8)，然後將充電電池抽出電動工具。**不可以強行拉出充電電池。**

充電電池的電量指示器

充電電池的電量指示器透過綠色 LED 燈告知充電電池的目前電量。基於安全顧慮，務必在電動工具完全靜止時才能檢查充電電池的電量。

按一下電量指示器按鈕  或 ，即可顯示目前的電量。即使已取出充電電池，此項功能仍可正常運作。

按壓電量顯示按鈕後，LED 燈若未亮起，即表示充電電池故障，必須予以更換。

提示：充電電池目前的電量也會顯示在使用者介面 (4) (參見「顯示目前狀態」，頁 33)。

充電電池型號 GBA 18V...



LED 燈	容量
3 顆綠燈持續亮起	60–100 %
2 顆綠燈持續亮起	30–60 %
1 顆綠燈持續亮起	5–30 %
1 顆綠燈呈閃爍狀態	0–5 %

充電電池型號 ProCORE18V...



LED 燈	容量
5 顆綠燈持續亮起	80–100 %
4 顆綠燈持續亮起	60–80 %
3 顆綠燈持續亮起	40–60 %
2 顆綠燈持續亮起	20–40 %
1 顆綠燈持續亮起	5–20 %
1 顆綠燈呈閃爍狀態	0–5 %

安裝防護裝置

▶ **在電動工具上進行任何維護的工作 (例如維修，更換工具等) 以及搬運和儲存電動工具之前，都必須電動工具中取出充電電池。**若是不小心觸動起停開關，可能造成人員受傷。

提示：如果砂輪於操作期間斷裂，或是防護罩上/電動工具上的支承構造發生受損情形，請務必儘快將電動工具送交顧客服務處修理，服務處地址請參照「顧客服務處和顧客諮詢中心」。

研磨專用防護罩

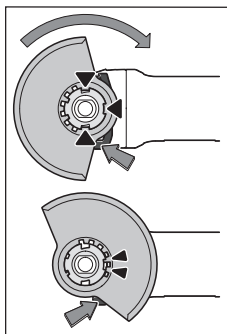

請將防護罩 (10) 放置到電動工具上的支座，防護罩的對位凸件應對準支座。同時按壓解扣桿 (1) 不要放開。

將防護罩 (10) 推至軸頭上，使防護罩的凸緣剛好位於電動工具的法蘭上，然後旋轉防護罩，直到清楚聽見卡上的聲音。

請依據工作程序的需求，適當調整防護罩 (10) 的位置。其做法是：將解扣桿 (1) 往上推，並將防護罩 (10) 轉至所需位置。

- ▶ 調整成防護罩 (10) 時：解扣桿 (1) 的兩個凸點一律要卡進防護罩上的對應凹處 (10)。
- ▶ 防護罩 (10) 應設置在能夠阻擋火花噴向操作人員的位置。
- ▶ 防護罩 (10) 僅能在按壓解扣桿 (1) 的狀態下旋轉！否則絕對不可繼續使用電動工具，而且必須送交顧客服務處。

提示：防護罩 (10) 上的對位凹凸設計可確保您所安裝的是與該電動工具相配的防護罩。

切割專用防護罩

- ▶ 以結合式磨具進行切割時，一律必須使用切割專用防護罩 (15)。
- ▶ 在石材上進行切割時，必須安裝合適的吸塵裝置。

切割專用防護罩 (15) 的安裝方式與研磨專用防護罩 (10) 相同。

輔助手柄

- ▶ 操作電動工具時務必使用輔助手柄 (9)。

根據工作要求，把輔助手柄 (9) 安裝在機頭的右側或左側。

具備減震功能的輔助手柄



具備減震功能的輔助手柄不僅能夠降低工作時的震動，更可以提高操作機器的舒適性和確保

工作安全。

- ▶ 切勿在輔助手柄上做任何修改。
- ▶ 勿繼續使用已經損壞的輔助手柄。

護手板

- ▶ 若要搭配橡膠磨盤 (20) 或杯形鋼絲刷/輪刷/千葉研磨砂輪進行作業，一律要安裝護手板 (19)。
- 請利用輔助手柄 (9) 固定護手板 (19)。

安裝磨具

- ▶ 在電動工具上進行任何維護的工作（例如維修，更換工具等）以及搬運和儲存電動工具之前，都必須從電動工具中取出充電電池。若是不小心觸動起停開關，可能造成人員受傷。

- ▶ 在研磨/割片尚未冷卻之前，切勿手握研磨/割片。作業時，切割片會變得非常炙熱。

將磨削主軸 (18) 以及準備裝上的所有部件都清潔乾淨。

夾緊和鬆開磨具時，請按壓主軸鎖止按鈕 (3)，以便鎖定磨削主軸。

- ▶ 待磨削主軸必須處於完全靜止狀態，才可使用主軸鎖止按鈕。否則可能造成電動工具損壞。

研磨砂輪/切割砂輪

請注意磨具的規格。磨具上的內孔直徑必須和配接法蘭完全吻合。切勿使用轉接頭和異徑管。

使用鑽石切割砂輪時，鑽石切割砂輪上的箭頭方向，必須和機器的轉向一致（參考機頭上的旋轉方向指示箭頭）。

安裝順序請參考工具詳解圖。

請用雙銷扳手旋上並鎖緊迫緊螺母 (13)，如此即可將砂輪/切割砂輪固定。

- ▶ 必須在安裝好磨具但尚未啟動機器前，檢查磨具是否正確裝牢、磨具能否自由無阻地旋轉。務必確定磨具轉動時不會和防護罩或其它機件產生磨擦。

千葉研磨砂輪

- ▶ 若要搭配千葉研磨砂輪進行作業，一律要安裝護手板 (19)。

橡膠磨盤

- ▶ 若要搭配橡膠磨盤 (20) 進行作業，一律要安裝護手板 (19)。

安裝順序請參考工具詳解圖。

將橡膠磨盤 (20) 推至磨削主軸 (18) 上。

將研磨片 (21) 牢牢按壓至橡膠磨盤 (20) 底部上。旋上圓螺母 (22) 然後用雙銷扳手將它鎖緊。

杯形鋼絲刷/輪刷

- ▶ 若要搭配杯形鋼絲刷或輪刷進行作業，一律要安裝護手板 (19)。

安裝順序請參考工具詳解圖。

把杯形鋼絲刷/輪刷裝入磨削主軸中，上述磨具必須緊靠在磨削主軸螺紋末端的法蘭上。使用開口扳手將杯形鋼絲刷/輪刷夾緊。

硬金屬杯形磨盤







- ▶ 必須搭配適用的防護罩才允許使用杯形磨盤。

機器允許使用的磨具

您可以使用本說明書中提到的所有磨具。

所選用的磨具其容許轉速 [次/分] 或圓周轉速 [m/s]，必須和以下表格中的數據一致。

因此，請您留意磨具標籤貼紙上的容許轉速或圓周轉速。

	最大 [mm]	[mm]		
	D	b	d	[次/分] [m/s]
	100	7	16	11000 80
	100	-	-	11000 80
	75	30	M 14	11000 45
	82	-	M 14	11000 80

轉動機頭 (GWS 18V-15 C)

- ▶ 在電動工具上進行任何維護的工作 (例如維修, 更換工具等) 以及搬運和儲存電動工具之前, 都必須電動工具中取出充電電池。若是不小心觸動起停開關, 可能造成人員受傷。

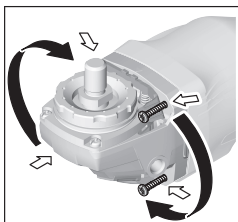

您可根據需要分段式轉動機頭, 每一段的旋轉角度為 90 度。此一設計的優點是能夠在特殊的工作狀況下, 把起停開關移至比較容易操作的位置, 例如針對左撇子。

先將 4 個螺絲旋出。小心地把機頭旋轉到所需

位置上, 無須從機殼上拆下機頭。裝回 4 個螺絲並將其重新旋緊。

吸鋸塵/吸鋸屑

含鉛的顏料及部分木材、礦物和金屬的加工廢塵有害健康。機器操作者或者工地附近的人如果接觸、吸入這些廢塵, 可能會有過敏反應或者感染呼吸道疾病。

特定粉塵 (例如加工橡木或山毛櫸的廢塵) 可能致癌, 特別是與處理木材的添加劑 (例如木材的防腐劑等) 混合之後。只有經過專業訓練的人才允許加工含石棉的物料。

- 工作場所要保持空氣流通。
- 建議佩戴 P2 濾網等級的口罩。

請留意並遵守貴國與加工物料有關的法規。

轉速預設 (GWS 18V-15 SC)

原廠設定共預設了 3 個轉速檔位。透過一個專屬應用程式 Bosch Toolbox App, 最多可設置 6 個轉速檔位。

轉速檔位的數量一經變更, 各個檔位的預設轉速值也跟著調整。這時候, 轉速檔位/模式指示器 (28) 將亮起白燈。您若單獨設置了某個轉速值, 那麼選用此一轉速檔位時, 轉速檔位/模式指示器 (28) 將亮藍燈

- ▶ 避免讓工作場所堆積過多的塵垢。塵埃容易被點燃。

操作

操作機器

安裝充電電池

請將充好電的充電電池 (7) 從前方推入電動工具底座, 讓充電電池確實卡上。

啟動/關閉

若要讓電動工具開始運轉, 請將起停開關 (5) 往前推。

若要鎖定起停開關 (5) 的位置, 請按壓起停開關 (5) 前端, 直到其卡止。

若要關閉電動工具, 請直接放開起停開關 (5) 即可, 或者當它處於卡止狀態時, 請短按一下起停開關 (5) 後端並隨即放開。

- ▶ 開機前, 先檢查是否已經正確地安裝好磨具, 觀察磨具轉動時會不會產生磨擦, 並且要進行至少 1 分鐘的無負載試機。切勿使用損壞、變形或轉動時會震動的磨具。損壞的磨具可能斷裂並造成人員受傷。

反彈斷電功能



電動工具驟然反彈時 (例如卡死在切口內), 將中斷饋送至馬達的供電。此時, 反彈斷電功能指示器 (26) 將亮起。反彈斷電功能啟用時, 狀態指示器 (30) 呈紅色閃爍狀態。

若想要讓工具重新運轉, 請將起停開關 (5) 移至關閉位置, 然後再重新啟動電動工具。

防止再起動功能

防止再起動功能可以避免電動工具在供電中斷之後, 突然失控地再度起動。

防止再起動功能啟用時, 狀態指示器 (30) 呈紅色閃爍狀態。

若想要讓工具重新運轉, 請將起停開關 (5) 移至關閉位置, 然後再重新啟動電動工具。

撞擊斷電功能

電動工具內建撞擊斷電功能, 一碰撞地面就會隨即斷電關機。此時狀態指示器 (30) 將呈紅色閃爍狀態。

若想要讓工具重新運轉, 請將起停開關 (5) 移至關閉位置, 然後再重新啟動電動工具。

使用者介面 (請參考圖 A)

使用者介面 (4) 可用來預設轉速以及示意電動工具的目前狀態。

(代表不是原來的的基本設定)。轉速檔位進行個別調整時，每次的調幅為 200 次/分。此時，請注意檔位的轉速應為遞增 (即 $2 \geq 1/3 \geq 2$ 等)。

下表針對可設置的檔位數量分別列出其預設轉速 (基本設定)。

GWS 18V-15 SC	各檔位的轉速基本設定					
	1	2	3	4	5	6
	[次/分]	[次/分]	[次/分]	[次/分]	[次/分]	[次/分]
轉速檔位數量						
1	3400	-	-	-	-	-
2	3400	9800	-	-	-	-
3	3400	6600	9800	-	-	-
4	3400	5600	7600	9800	-	-
5	3400	5000	6600	8200	9800	-
6	3400	4600	6000	7200	8600	9800

此處提供的轉速檔位資料需視所使用的充電電池、充電電池的電量和裝置的操作溫度而定。

利用轉速預設按鈕 (27) 即使是在工具運作期間，亦可按照需求設定轉速。下表為您提供原廠設定的 3 個預設轉速檔位，相關數據僅供參考。

工件物料	用途	嵌件工具	預設的轉速檔位	GWS 18V-15 SC [次/分]
金屬	刷磨、除鏽	杯形鋼絲刷	1	3400
優質不鏽鋼	研磨	纖維墊片	2	6600
金屬	粗磨	研磨砂輪	3	最大值
金屬	切割	研磨砂輪	3	最大值
石材	切割	鑽石切割砂輪和引導板 (必須使用引導板才允許進行石材切割)	3	最大值

- 配件的額定速率必須至少等於電動工具上所標示的最大速率。配件的運轉速度若高於其額定速率，可能會造成其破損並解體。

顯示目前狀態

充電電池的電量指示器 (使用者介面) (25)	代表意義/原因	解決辦法
綠色	為充電電池進行充電	-
黃色	充電電池的電量即將用盡	儘快更換充電電池或為其充電
紅色	充電電池的電量用盡了	更換充電電池或為其充電

溫度指示器 (31)	代表意義/原因	解決辦法
黃色	已達到臨界溫度 (馬達、電子部件、充電電池)	讓電動工具空轉並降溫冷卻
紅色	電動工具過熱並隨即關機	讓電動工具降溫冷卻

電動工具狀態指示器 (30)	代表意義/原因	解決辦法
綠色	正常狀態	-
黃色	已達到臨界溫度或充電電池的電量即將用盡	讓電動工具空轉並降溫冷卻，或是儘快更換充電電池/為其充電
亮起紅燈	電動工具過熱或充電電池已無電力	讓電動工具降溫冷卻，或是更換充電電池/為其充電

電動工具狀態指示器 (30)	代表意義/原因	解決辦法
紅色閃爍	已觸發反彈斷電功能、防止再起動功能或撞擊斷電功能	將電動工具先關機，然後再重新啟動
藍色閃爍	電動工具已與行動終端裝置連線，或正在傳輸設定	-

連線後支援的功能

搭配使用藍牙® Low Energy Module **GCY 42** 時，電動工具連線後支援以下功能：

- 註冊及植入個人化設置
- 狀態檢測、發送警告訊息
- 提供一般資訊、設定工具
- 管理

如需 Bluetooth® Low Energy Module **GCY 42** 的相關資訊，請詳讀其操作說明書。

必須按壓使用者介面 (4) 上的轉速預設按鈕 (27) 以確認電動工具要與 App 連線。連線時 App 會向您提出此項要求。

作業注意事項

- ▶ 搭載 Bluetooth® Low Energy Module **GCY 42** 的電動工具配備無線介面。請您務必遵守不同場所的使用限制條件，例如在飛機或醫院內。
- ▶ 進入禁止使用藍牙® 無線技術的區域時，藍牙® Low Energy Module **GCY 42** 以及鈕扣電池必須取下。
- ▶ 在支撐牆上開縫時必須特別小心，參考「有關靜力學的注意事項」章節。
- ▶ 無法穩固站位的工件需要另外夾緊。
- ▶ 勿讓電動工具因過載而停止轉動。
- ▶ 電動工具負載過重之後，必須空轉數分鐘，讓嵌件工具冷卻。
- ▶ 不可以把電動工具安裝在切割研磨架上操作。
- ▶ 在研磨/割片尚未冷卻之前，切勿持握研磨/割片。作業時，切割片會變得非常炙熱。

如果電動工具積蓄了靜電，電子裝置會自動關閉電動工具。若要重新啟動電動工具，請再次按下起停開關 (5)。

粗磨

- ▶ 勿使用切割砂輪進行粗磨作業。

粗磨時以操作角度 30° 至 40° 進行加工，即可達到最佳粗磨效果。操作時只須輕壓並來回地移動機器，如此工件才不會過熱、變色，物件表面也不會出現凹陷的痕跡。

千葉研磨砂輪

使用千葉研磨砂輪 (配件) 可以在隆起的表面和具有凹凸花紋的材料上研磨。

千葉研磨砂輪的使用壽命，會比一般砂輪的使用壽命長。而且它的工作噪音和研磨溫度也比較低。

切割金屬

- ▶ 以結合式磨具進行切割時，一律必須使用切割專用防護罩 (15)。

切割時必須施力均勻，得根據工件的材質來決定推進的力道。操作機器時勿重壓、傾斜或搖晃機器。不可用側壓的方式來制止切割砂輪繼續轉動。

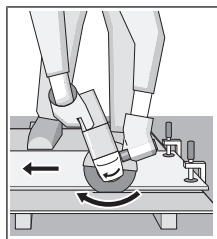

必須逆著機器的轉向推動電動工具，否則可能會因其失控而滑出預先規劃的切線。

切割具有凹凸花紋的材料及方管時，最好從橫斷面最小的位置著手。

切割石材

- ▶ 在石材上進行切割時，必須安裝合適的吸塵裝置。
- ▶ 請佩戴防塵面罩。
- ▶ 本電動工具只能夠進行乾式切割和乾式研磨。

切割石材時最好使用鑽石切割砂輪。

切割高硬度的工件時 (例如碎石含量很高的水泥)，鑽石切割砂輪可能因為過熱而損壞。您可從鑽石切割砂輪周圍出現環狀火花確認發生這種情況。

此時必須停下工作，讓鑽石切割砂輪在空載的狀況下以最高轉速運作片刻，這樣做有助於降溫。

如果切割砂輪的切割效率明顯降低，而且進行切割時會出現環狀火花，即表示鑽石切割砂輪已經變鈍。如果發生上述狀況，可以把切割砂輪在研磨材料上 (例如石灰砂石) 來回刷磨數次，這樣切割砂輪又會鋒利如初。

有關靜力學的注意事項

關於在支撐牆上開縫時應該注意的事項，請參考 DIN 1053 第 1 部份中的規定，或各國有關的法規。務必確實遵循相關的法令規定。正式動工以前，先向負責的靜力學專家、建築設計師或工程負責人請教相關細節。

如何正確地使用充電電池

妥善保護充電電池，避免濕氣和水分滲入。

充電電池必須儲存在 -20 °C 至 50 °C 的環境中。夏天不可以把充電電池擱置在汽車中。

偶爾用柔軟、乾淨且乾燥的毛刷清潔充電電池的通氣孔。

充電後如果充電電池的使用時間明顯縮短，代表充電電池已經損壞，必須更換新的充電電池。

請您遵照廢棄物處理相關指示。

維修和服務

保養與清潔

- ▶ 在電動工具上進行任何維護的工作（例如維修，更換工具等）以及搬運和儲存電動工具之前，都必須電動工具中取出充電電池。若是不小心觸動起停開關，可能造成人員受傷。
- ▶ 電動工具和通風口都必須保持清潔，這樣才能夠提高工作品質和安全性。

小心地保存和使用配件。

顧客服務處和顧客諮詢中心

本公司顧客服務處負責回答有關本公司產品的維修、維護和備用零件的問題。以下的網頁中有分解圖和備用零件相關資料：www.bosch-pt.com
如果對本公司產品及其配件有任何疑問，博世應用諮詢小組很樂意為您提供協助。
當您需要諮詢或訂購備用零件時，請務必提供本產品型號銘牌上 10 位數的產品機號。

台灣

台灣羅伯特博世股份有限公司
建國北路一段90號6樓
台北市10491
電話: (02) 7734 2588
傳真: (02) 2516 1176
www.bosch-pt.com.tw

製造商地址:

Robert Bosch Power Tools GmbH
羅伯特·博世電動工具有限公司
70538 Stuttgart / GERMANY
70538 斯圖加特/ 德國

以下更多客戶服務處地址：

www.bosch-pt.com/serviceaddresses

搬運

隨貨附上的鋰離子充電電池受危險物品法的規範。使用者無須另外使用保護包裝便可運送該充電電池。

但是如果將它交由第三者運送（例如：寄空運或委託運輸公司），則應遵照包裝與標示的相關要求。此時必須向危險物品專家請教有關寄送危險物品的相關事宜。

確定充電電池的外殼未受損後，才可以寄送充電電池。用膠帶貼住裸露的接點並妥善包裝充電電池，不可以讓充電電池在包裝材料中晃動。同時也應留意各國相關法規。

廢棄物處理



必須以符合環保的方式，將損壞的電動工具、充電電池、配件和包裝材料進行回收再利用。



不可以把電動工具和充電電池／拋棄式電池丟入一般家庭垃圾中！

充電電池／拋棄式電池：

鋰離子：

請注意「搬運」段落中的指示（參見「搬運」，頁 35）。

한국어

안전 수칙

전동공구용 일반 안전수칙

⚠ 경고

모든 안전수칙과 지시 사항을
상세히 읽고 지켜야 합니다. 다

음의 안전수칙과 지시 사항을 준수하지 않으면 화재 위험이 있으며 감전 혹은 중상을 입을 수 있습니다.

앞으로 참고할 수 있도록 이 안전수칙과 사용 설명서를 잘 보관하십시오.

다음에서 사용되는 "전동공구"라는 개념은 전원에 연결하여 사용하는 (전선이 있는) 전동 기기나 배터리를 사용하는 (전선이 없는) 전동 기기를 의미합니다.

작업장 안전

- ▶ **작업장을 항상 깨끗이 하고 조명을 밝게 하십시오.** 작업장 환경이 어수선하거나 어두우면 사고를 초래할 수 있습니다.
- ▶ **가연성 유체, 가스 또는 분진이 있어 폭발 위험이 있는 환경에서 전동공구를 사용하지 마십시오.** 전동공구는 분진이나 증기에 점화하는 스파크를 일으킬 수 있습니다.
- ▶ **전동공구를 사용할 때 구경꾼이나 어린이 혹은 다른 사람이 작업장에 접근하지 못하게 하십시오.** 다른 사람이 주의를 산만하게 하면 기기에 대한 통제력을 잃기 쉽습니다.

전기에 관한 안전

- ▶ **전동공구의 전원 플러그가 전원 콘센트에 잘 맞아야 합니다.** 플러그를 절대 변경시켜서는 안 됩니다. (접지된) 전동공구를 사용할 때 어댑터 플러그를 사용하지 마십시오. 변형되지 않은 플러그와 잘 맞는 콘센트를 사용하면 감전의 위험을 줄일 수 있습니다.
- ▶ **파이프 관, 라디에이터, 레인지, 냉장고와 같은 접지 표면에 몸이 닿지 않도록 하십시오.** 몸에 닿을 경우 감전될 위험이 높습니다.
- ▶ **전동공구를 비에 맞지 않게 하고 습기 있는 곳에 두지 마십시오.** 전동공구에 물이 들어가면 감전될 위험이 높습니다.
- ▶ **전원 코드를 잘못 사용하는 일이 없도록 하십시오.** 전원 코드를 잡고 전동공구를 운반해서는 안 되며, 콘센트에서 전원 플러그를 뽑을 때 전원 코드를 잡아 당겨서는 절대로 안 됩니다. 전원 코드가 열과 오일에 접촉하는 것을 피하고, 날카로운 모서리나 기기의 가동 부위에 닿지 않도록 주의

하십시오. 손상되거나 영킨 전원 코드는 감전을 유발할 수 있습니다.

- ▶ 실외에서 전동공구로 작업할 때는 실외용으로 적당한 연장 전원 코드만을 사용하십시오. 실외용 연장 전원 코드를 사용하면 감전의 위험을 줄일 수 있습니다.
- ▶ 전동공구를 습기 찬 곳에서 사용해야 할 경우에는 누전 차단기를 사용하십시오. 누전 차단기를 사용하면 감전 위험을 줄일 수 있습니다.

사용자 안전

- ▶ 신중하게 작업하며, 전동공구를 사용할 때 경솔하게 행동하지 마십시오. 피로한 상태이거나 약물 복용 및 음주한 후에는 전동공구를 사용하지 마십시오. 전동공구를 사용할 때 잠시라도 주의가 산만해지면 중상을 입을 수 있습니다.
- ▶ 작업자 안전을 위한 장치를 사용하십시오. 항상 보안경을 착용하십시오. 전동공구의 종류와 사용에 따라 먼지 보호 마스크, 미끄러지지 않는 안전한 신발, 안전모 또는 귀마개 등의 안전한 복장을 하면 상해의 위험을 줄일 수 있습니다.
- ▶ 실수로 기기가 작동되지 않도록 주의하십시오. 전동공구를 전원에 연결하거나 배터리를 끼우기 전에, 혹은 기기를 들거나 운반하기 전에, 전원 스위치가 꺼져 있는지 다시 확인하십시오. 전동공구를 운반할 때 전원 스위치에 손가락을 대거나 전원 스위치가 켜진 상태에서 전원을 연결하면 사고 위험이 높습니다.
- ▶ 전동공구를 사용하기 전에 조절하는 돌이나 키 등을 빼 놓으십시오. 회전하는 부위에 있는 돌이나 키로 인해 상처를 입을 수 있습니다.
- ▶ 자신을 과신하지 마십시오. 불안정한 자세를 피하고 항상 평형을 이룬 상태로 작업하십시오. 안정된 자세와 평형한 상태로 작업해야만이 의외의 상황에서 전동공구를 안전하게 사용할 수 있습니다.
- ▶ 알맞은 작업복을 입으십시오. 헐렁한 복장을 하거나 장신구를 착용하지 마십시오. 머리카락 또는 장갑이 가동하는 기기 부위에 가까이 닿지 않도록 주의하십시오. 헐렁한 복장, 장신구 혹은 긴 머리는 가동 부위에 말려 사고를 초래할 수 있습니다.
- ▶ 분진 추출장치나 수거장치의 조립이 가능한 경우, 이 장치가 연결되어 있는지, 제대로 작동이 되는지 확인하십시오. 이러한 분진 추출장치를 사용하면 분진으로 인한 사고 위험을 줄일 수 있습니다.

전동공구의 올바른 사용과 취급

- ▶ 기기를 과부하 상태에서 사용하지 마십시오. 작업할 때 이에 적당한 전동공구를 사용하십시오. 알맞은 전동공구를 사용하면 지정된 성능 한도 내에서 더 효율적으로 안전하게 작업할 수 있습니다.
- ▶ 전원 스위치가 고장 난 전동공구를 사용하지 마십시오. 전원 스위치가 작동되지 않는 전동공구는 위험하므로, 반드시 수리를 해야 합니다.

- ▶ 기기에 세팅을 하거나 액세서리 부품을 교환하거나 혹은 기기를 보관할 때, 항상 전원 콘센트에서 플러그를 미리 빼어 놓으십시오. 이러한 조치는 실수로 전동공구가 작동하게 되는 것을 예방합니다.
- ▶ 사용하지 않는 전동공구는 어린이 손이 닿지 않는 곳에 보관하고, 전동공구 사용에 익숙하지 않거나 이 사용 설명서를 읽지 않은 사람은 기기를 사용하지 않습니다. 경험이 없는 사람이 전동공구를 사용하면 위험합니다.
- ▶ 전동공구를 조심스럽게 관리하십시오. 가동 부위가 하자 없이 정상적인 기능을 하는지, 걸리는 부위가 있는지, 혹은 전동공구의 기능에 중요한 부품이 손상되지 않았는지 확인하십시오. 손상된 기기의 부품은 전동공구를 다시 사용하기 전에 반드시 수리를 맡기십시오. 제대로 관리하지 않은 전동공구의 경우 많은 사고를 유발합니다.
- ▶ 절단 공구를 날카롭고 깨끗하게 관리하십시오. 날카로운 절단면이 있고 잘 관리된 절단공구는 걸리는 경우가 드물고 조절하기도 쉽습니다.
- ▶ 전동공구, 액세서리, 장착하는 공구 등을 사용할 때, 이 지시 사항과 특별히 기종 별로 나와있는 사용 방법을 준수하십시오. 이때 작업 조건과 실시하려는 작업 내용을 고려하십시오. 원래 사용 분야가 아닌 다른 작업에 전동공구를 사용할 경우 위험한 상황을 초래할 수 있습니다.

충전 전동공구의 올바른 사용과 취급

- ▶ 배터리를 충전할 때 제조 회사가 추천하는 충전기만을 사용하여 재충전해야 합니다. 특정 제품의 배터리를 위하여 제조된 충전기에 적합하지 않은 다른 배터리를 충전할 경우 화재 위험이 있습니다.
- ▶ 각 전동공구용으로 나와있는 배터리만을 사용하십시오. 다른 종류의 배터리를 사용하면 상해를 입거나 화재를 초래할 수 있습니다.
- ▶ 배터리를 사용하지 않을 때는, 각 극을 자극 할 수 있는 페이퍼 클립, 동전, 열쇠, 못, 나사 등 유사한 금속성 물체와 멀리하여 보관하십시오. 배터리 극 사이에 쇼트가 일어나 화상을 입거나 화재를 야기할 수 있습니다.
- ▶ 배터리를 잘못 사용하면 누수가 생길 수 있습니다. 누수가 생긴 배터리에 닿지 않도록 하십시오. 피부에 접촉하게 되었을 경우 즉시 물로 씻으십시오. 유체가 눈에 닿았을 경우 바로 의사와 상담하십시오. 배터리에서 나오는 유체는 피부에 자극을 주거나 화상을 입힐 수 있습니다.

서비스

- ▶ 전동공구 수리는 반드시 전문 인력에게 맡기고, 수리 정비 시 보쉬 순정 부품만을 사용하십시오. 그렇게 함으로써 기기의 안전성을 오래 유지할 수 있습니다.

앵글 그라인더용 안전 수칙

그라인딩, 샌딩, 와이어 브러싱 또는 연삭 절단 작업에 대한 일반 안전 경고사항

- ▶ 본 전동공구는 그라인더, 샌더, 와이어 브러시 또는 연삭 절단 공구와 같은 용도로 사용하기 위해 설계되었습니다. 본 전동공구와 함께 제공된 모든 안전경고, 지시사항, 그림 및 사양을 숙지하십시오. 다음의 지시 사항을 준수하지 않으면 감전, 화재, 또는 심각한 부상을 초래할 수 있습니다.
- ▶ 본 전동공구로 폴리싱과 같은 작업을 진행하는 것은 권장하지 않습니다. 본 전동공구의 설계 용도에 부합하지 않는 작업은 위험 상황 및 몸의 부상을 야기할 수 있습니다.
- ▶ 명확하게 설계되지 않았거나 공구 제조사에서 권장하지 않는 액세서리는 사용하지 마십시오. 액세서리를 공구에 부착할 수 있다고 해서 안전한 작동이 보장되는 것은 아닙니다.
- ▶ 액세서리의 정격 속도는 적어도 공구에 표시되어 있는 최고 속도와 동일해야 합니다. 정격 속도보다 빠르게 작동되는 액세서리는 파손되어 분리될 수 있습니다.
- ▶ 액세서리의 외경 및 두께는 공구가 수용할 수 있는 범위 내에 있어야 합니다. 액세서리의 사이즈가 부정확한 경우 제대로 보호받지 못하거나 제어되지 않을 수 있습니다.
- ▶ 액세서리에 끼워진 마운팅은 그라인더 스피너나 사산과 일치해야 합니다. 플랜지가 장착된 액세서리의 경우 액세서리의 주축 구멍이 플랜지의 로케이팅 직경에 맞아야 합니다. 전동공구의 하드웨어에 맞지 않는 액세서리를 장착할 경우 중심을 잃고 과도하게 진동하며, 통제력을 상실하게 됩니다.
- ▶ 손상된 액세서리를 사용하지 마십시오. 사용하기 전에 항상 연삭 휠이 휘어지거나 갈라지지 않았는지, 이면 패드가 갈라지거나 또는 찢어지거나 과도하게 마모되지 않았는지, 와이어 브러시의 와이어가 느슨하거나 갈라지지 않았는지 액세서리를 점검하십시오. 전동공구나 액세서리를 떨어뜨린 경우 손상된 부분이 있는지 확인하고, 손상된 경우 손상되지 않은 액세서리를 설치하십시오. 액세서리를 점검 및 설치한 뒤 회전하는 액세서리 작업대에서 거리를 멀리 유지하고 전동공구를 1분 간 최대 무부하 속도로 작동시키십시오. 액세서리가 손상된 경우 일반적으로 테스트 도중에 떨어져 나갈 것입니다.
- ▶ 신체 보호 장비를 착용하십시오. 용도에 따라 안전 보호구, 안전 고글 또는 보안경을 착용하십시오. 필요한 경우, 작은 연삭 파편 또는 가공품 파편을 막을 수 있는 방진 마스크, 청력 보호구, 장갑 및 작업용 앞치마를 착용하십시오. 보안경은 여타 작업을 진행하면서 생성되는 비산 파편들을 차단할 수 있어야 합니다. 마스크나 방독 마스크는 작업하면서 생성되는 먼지를 걸러낼 수 있어야 합니다. 오랫동안 고강도의 소음에 노출되면 청력이 손상될 수 있습니다.
- ▶ 주변 사람들이 작업 영역으로부터 안전거리를 유지하게 하십시오. 작업 영역에 진입하는 사람은

모두 신체 보호 장치를 착용해야 합니다. 가공품 또는 손상된 액세서리 파편이 작업 중인 곳을 벗어나서 날아가 부상을 초래할 수 있습니다.

- ▶ 절단용 액세서리가 숨겨진 배선에 접촉할 가능성이 있는 작업을 수행할 경우, 전동공구의 절연된 손잡이 면만 잡으십시오. 절단용 액세서리가 "전류가 흐르는" 전선에 접촉되면, 전동공구의 노출된 금속 부품에 "전류가 흐르는" 상태로 만들어 작업자가 감전될 수 있습니다.
- ▶ 액세서리가 완전히 멈출 때까지 절대 전동공구를 내려 놓지 마십시오. 회전 액세서리가 표면에 달라붙어 전동공구를 제어하지 못하게 될 수 있습니다.
- ▶ 전동공구를 곁에 두고 이동시킬 때 공구를 작동시키지 마십시오. 실수로 회전 액세서리에 닿게 되면 옷이 휘감겨 액세서리가 몸에 박힐 수 있습니다.
- ▶ 전동공구의 통풍구를 주기적으로 청소하십시오. 모터의 팬은 하우징 내부로 먼지를 흡입하는데, 금속 가루가 너무 많이 쌓이면 전기 사고 위험을 초래할 수 있습니다.
- ▶ 가연성 소재 근처에서 전동공구를 작동시키지 마십시오. 스파크로 인해 점화될 수 있습니다.
- ▶ 냉각용 액체가 필요한 액세서리는 사용하지 마십시오. 물이나 기타 액체 냉매를 이용하면 감전되거나 감전사할 수 있습니다.

반동 및 관련 경고사항

반동이란 회전하는 휠, 이면 패드, 브러시 또는 기타 액세서리가 꼭 끼이거나 장애물에 걸려 생기는 갑작스런 반작용을 의미합니다. 장애물에 끼이거나 걸리게 되면 회전하는 액세서리가 빠른 속도로 멈추게 되고, 이로 인해 통제력을 잃은 전동공구는 걸린 지점에서 액세서리 회전 방향의 반대 방향으로 밀립니다.

예를 들어, 연삭 휠이 가공품에 걸리거나 끼일 경우, 끼인 지점으로 들어가는 휠 가장자리가 가공물의 표면을 파고 들어 휠이 튕겨 나올 수 있습니다. 끼인 지점에서의 휠 운동 방향에 따라 휠이 작업자 측 또는 그 반대 방향으로 튕 수 있습니다. 이러한 경우에는 연마 휠도 파손될 수 있습니다.

반동은 공구를 잘못 사용하거나 잘못된 조작 절차 또는 조건으로 인해 발생할 수 있으며 아래와 같은 적절한 예방 조치를 통해 반동을 막을 수 있습니다.

- ▶ 전동공구를 꽉 잡고 반발력에 저항할 수 있는 자세를 유지하십시오. 보조 손잡이가 있는 경우 항상 보조 손잡이를 이용하여 반동이나 시동 중에 토크 반발력을 최대한 제어할 수 있도록 하십시오. 작업자가 적절한 예방 조치를 취한다면 토크 반발력이나 반동력을 제어할 수 있습니다.
- ▶ 회전하는 액세서리에 손을 절대 가까이 두지 마십시오. 액세서리가 손쪽으로 튕겨 나올 수 있습니다.
- ▶ 반동으로 인해 전동공구가 튕겨 나올 수 있는 곳에서 있지 마십시오. 반동은 휠이 걸린 지점에서 공구가 휠 움직임과 반대되는 방향으로 튕겨 나가게 합니다.

- ▶ 모서리, 날카로운 가장자리 등을 가공할 때는 특히 주의하십시오. 액세서리가 튕겨 나가거나 걸리지 않게 하십시오. 모서리, 날카로운 가장자리 또는 탄성력이 있는 부분에는 회전하는 액세서리가 걸려 통제력을 잃거나 튀어 오르기 쉽습니다.
- ▶ 전기톱 목공용 날이나 톱니가 있는 톱날을 부착하지 마십시오. 이러한 톱날은 반동을 유발하거나 통제력을 잃게 하는 경우가 많습니다.

그라인딩 및 연삭 절단 작업에 대한 추가 안전 경고 사항

- ▶ 사용하는 전동공구에 권장하는 유형의 휠 및 선택한 휠용으로 설계된 특수 보호대만 사용하십시오. 전동공구의 설계에 맞지 않는 휠은 제대로 보호되지 않으며, 안전하지 않습니다.
- ▶ 가운데 부분이 눌린 휠의 연마 표면은 가드 림의 평면 아래에 장착되어야 합니다. 가드 림의 면을 통해 나오는 휠이 제대로 장착되지 않으면 휠이 제대로 보호받을 수 없습니다.
- ▶ 전동공구에 가드를 단단히 장착하고 안착시켜야만 안전성이 극대화되고, 작업자 쪽으로 최소한의 휠 부분이 노출됩니다. 가드는 휠 파편의 손상, 실수로 휠과 접촉하거나, 옷에 불이 붙을 수 있는 스파크로부터 작업자를 보호해 줍니다.
- ▶ 휠은 권장된 용도로만 사용해야 합니다. 예를 들어, 절단 휠 측면에 그라인딩 작업을 하지 마십시오. 연삭 절단 휠은 원주 연삭 용도로 사용되며, 휠의 측면에 힘을 주면 산산이 부서질 수 있습니다.
- ▶ 항상 선택한 휠에 맞는 크기와 모양을 갖춘 손상되지 않은 휠 플랜지를 사용하십시오. 적합한 휠 플랜지는 휠을 받쳐주어 휠이 파손될 가능성을 줄여줍니다. 절단 휠 플랜지는 연마 휠 플랜지와 차이가 있을 수 있습니다.
- ▶ 더 큰 전동공구에서 사용했던 마모된 휠을 사용하지 마십시오. 더 큰 전동공구용으로 제작된 휠은 작은 공구의 빠른 속도에 적합하지 않아 파열될 수 있습니다.

연삭 절단 작업에 대한 추가 안전 경고사항

- ▶ 절단 휠이 “걸리게”하거나 과도한 압력을 가하지 마십시오. 지나치게 깊이 절단하려 하지 마십시오. 휠에 과도한 압력을 가하면 부하가 증가해 휠이 뒤틀리거나 절단 부위에 고착되고, 반동이 생기거나 또는 휠이 파손될 수 있습니다.
- ▶ 회전하는 휠과 일직선상 또는 뒤쪽에서 있지 마십시오. 작업 위치에서 휠이 작업자의 몸에서 멀어져 가고 있을 경우 반동으로 인해 회전하는 휠과 전동공구가 작업자에게 바로 튕겨나갈 수 있습니다.
- ▶ 어떤 이유로든 휠이 고착되거나 절단되지 않을 경우 전동공구의 전원을 끄고 휠이 완전히 멈출 때까지 전동공구를 잡고 계십시오. 휠이 움직이는 동안은 절단 부위에서 절단 휠을 떼어내지 마십시오. 그렇지 않으면 반동이 생길 수 있습니다. 점검한 후 휠 고착 원인을 제거하십시오.
- ▶ 가공물에서 다시 절단 작업을 시작하지 마십시오. 휠이 최대 속도에 도달하면 조심스럽게 다시 절단을 시작하십시오. 가공물에서 다시 전동공

구를 가동하면 휠이 고착되거나 가공물을 타고 획 올라가거나 튕겨나갈 수 있습니다.

- ▶ 패널 또는 사이즈가 큰 가공물은 받침대로 받쳐 주어 휠이 끼여 반동이 발생할 수 있는 위험을 최소한으로 줄이십시오. 가공물이 너무 크면 그 무게로 인해 처질 수 있습니다. 받침대는 가공물 아래 절단선 가까이, 그리고 휠 양쪽의 가공물 가장자리 가까이에 배치해야 합니다.
- ▶ 기존의 벽 또는 앞이 안 보이는 다른 곳에 “포켓 절단 작업”을 할 때는 각별히 주의하십시오. 휠이 전진하면서 가스관이나 수도관, 전기 배선 또는 반동을 유발할 수 있는 물체를 절단할 수 있습니다.

샌딩 작업에 대한 안전 경고사항

- ▶ 과도하게 큰 샌딩 디스크 페이퍼를 사용하지 마십시오. 샌딩 페이퍼를 선택할 때는 제조업체에서 권장하는 사항을 따르십시오. 샌딩 패드 크기보다 큰 샌딩 페이퍼를 사용할 경우 부상을 입을 위험이 있으며, 디스크가 걸리거나 찢어지거나 또는 반동이 유발될 수 있습니다.

와이어 브러싱 작업에 대한 특별 안전 경고사항

- ▶ 일반적인 작업 중 브러시의 와이어 강도가 날릴 수 있다는 점에 유의하십시오. 브러시에 무리한 힘을 가하여 과부하가 걸리지 않도록 하십시오. 와이어 강도는 얇은 옷 그리고/또는 피부를 쉽게 뚫고 들어갈 수 있습니다.
- ▶ 와이어 브러싱 작업에 가드 사용이 권장되는 경우, 가드에 와이어 휠 또는 브러시가 걸리는 일이 없게 하십시오. 와이어 휠 또는 브러시는 작업부하 및 원심력으로 인해 직경이 확대될 수 있습니다.

추가 안전 경고사항

보안경을 착용하십시오.



- ▶ 보이지 않는 부위에 에너지 배선 및 배관 여부를 확인하려면 적당한 탐지기를 사용하거나 담당 전력 공급회사에 문의하십시오. 전선에 접하게 되면 화재나 전기 충격을 야기할 수 있습니다. 가스관을 손상시키면 폭발 위험이 있습니다. 수도관을 파손하게 되면 재산 피해를 야기할 수 있습니다.
- ▶ 완전히 식을 때까지 연마석이나 절단석을 만지지 마십시오. 작업 시 매우 뜨거워지기 때문입니다.
- ▶ 배터리 분리 등으로 인해 전원 공급이 중단된 경우 전원 스위치를 풀고 OFF 위치에 놓으십시오. 이렇게 하면 실수로 기기가 다시 작동하는 것을 방지할 수 있습니다.
- ▶ 작업물을 잘 고정하십시오. 고정장치나 기계 바이스에 끼워서 작업하면 손으로 잡는 것보다 더 안전합니다.
- ▶ 배터리가 손상되었거나 잘못 사용될 경우 증기가 발생할 수 있습니다. 배터리에서 화재가 발생하거나 폭발할 수 있습니다. 작업장을 환기시키고,

필요한 경우 의사와 상담하십시오. 증기로 인해 호흡기가 자극될 수 있습니다.

- ▶ **배터리를 분해하지 마십시오.** 단락이 발생할 위험이 있습니다.
- ▶ **못이나 스크류 드라이버 같은 뾰족한 물체 또는 외부에서 오는 충격 등으로 인해 축전지가 손상될 수 있습니다.** 내부 단락이 발생하여 배터리가 타거나 연기가 발생하고, 폭발 또는 과열될 수 있습니다.
- ▶ **제조사 외의 배터리 제품만 사용하지 마십시오.** 그래야만 배터리 과부하의 위험을 방지할 수 있습니다.



배터리를 태양 광선 등 고열에 장시간 노출되지 않도록 하고 불과 오염물질, 물, 수분이 있는 곳에 두지 마십시오. 폭발 및 단락의 위험이 있습니다.



- ▶ 해당 무선설비는 전파혼신 가능성이 있으므로 인명안전 과 관련된 서비스는 할 수 없습니다.
- ▶ **주의! 전동공구의 Bluetooth® 기능 사용은 다른 기기나 설비, 비행기 및 의료기기(예: 심박 조정기, 보청기) 등에 장애를 가져올 수 있습니다.** 마찬가지로 근처에 있는 동물이나 사람에게도 좋지 않은 영향을 미칠 수 있습니다. 전동공구의 Bluetooth® 기능 사용은 의료 기기, 주유소, 화학 설비 및 폭발 위험이 있는 주변에서는 삼가하십시오. 비행기에서 전동공구의 Bluetooth® 기능 사용을 삼가하십시오. 오랜 시간 신체에 직접 접촉하여 작동하는 것을 삼가하십시오.

블루투스® 워드마크와 그림(로고)은 Bluetooth SIG, Inc.의 등록상표입니다. Robert Bosch Power Tools GmbH는 허가를 받아 이를 사용하고 있습니다.

제품 및 성능 설명



모든 안전 수칙과 지침을 숙지하십시오. 다음의 안전 수칙과 지침을 준수하지 않으면 화재 위험이 있으며 감전 혹은 중상을 입을 수 있습니다.

사용 설명서 앞 부분에 제시된 그림을 확인하십시오.

규정에 따른 사용

본 전동공구는 물을 사용하지 않고 금속이나 석재에 절단작업, 연마작업 또는 브러싱작업을 하는데 적합합니다.

절단석을 이용하여 절단작업을 할 경우, 특수한 절단작업용 안전반을 사용해야 합니다.

석재 절단 시에는 분진 추출장치가 설치되어 있어야 합니다.

허용된 연마공구를 사용하면 전동공구로 샌딩작업도 할 수 있습니다.

Bluetooth® Low Energy Module **GCY 42** 이 장착되어 있는 경우 Bluetooth®-무선 기술을 이용하여

전동공구와 모바일 단말기 간에 전동공구의 데이터 및 설정 내역을 전송할 수 있습니다.

제품의 주요 명칭

제품의 주요 명칭에 표기되어 있는 번호는 기기 그림이 나와있는 면을 참고하십시오.

- (1) 안전반 해제 레버
- (2) 하우징에 있는 회전 방향 화살표
- (3) 스피들 잠금 버튼
- (4) 사용자 인터페이스
- (5) 전원 스위치
- (6) 블루투스® Low Energy Module GCY 42 커버
- (7) 배터리^{A)}
- (8) 배터리 해제 버튼^{A)}
- (9) 보조 손잡이(절연된 손잡이 부위)
- (10) 연마 작업용 안전반
- (11) O링이 있는 수동 플랜지
- (12) 연마석
- (13) 클램핑 너트
- (14) 초경-포트 타입 디스크^{A)}
- (15) 절단용 안전반^{A)}
- (16) 절단석^{A)}
- (17) 손잡이(절연된 손잡이 부위)
- (18) 연삭 스피들
- (19) 손 보호대^{A)}
- (20) 고무판^{A)}
- (21) 샌딩 페이퍼^{A)}
- (22) 원형 너트^{A)}
- (23) 컵 브러시^{A)}
- (24) 다이아몬드 드릴 비트^{A)}
- (25) 배터리 충전 상태 표시기(사용자 인터페이스)
- (26) 급반동 멈춤 기능 표시기(사용자 인터페이스)
- (27) 회전속도 조절 선택 버튼(사용자 인터페이스)
- (28) 회전속도 단계/모드 표시기(사용자 인터페이스)
- (29) 스마트폰 표시기(사용자 인터페이스)
- (30) 전동공구 상태 표시기(사용자 인터페이스)
- (31) 온도 표시기(사용자 인터페이스)
- (32) 팬 그라인딩 디스크^{A)}

^{A)} 도면이나 설명서에 나와있는 액세서리는 표준 공급부품에 속하지 않습니다. 전체 액세서리는 저희 액세서리 프로그램을 참고하십시오.

제품 사양

앵글 그라인더		GWS 18V-15 C	GWS 18V-15 SC
제품 번호		3 601 JH6 0..	3 601 JH6 1..
정격 전압	V=	18	18
정격 속도 ^{A)}	min ⁻¹	11000	11000
무부하 속도 ^{B)}	min ⁻¹	9800	3400-9800
연마석 최대 직경	mm	100	100
연삭 스피들 나사		M 10	M 10
연삭 스피들의 최대 나사 길이	mm	16	16
급반동 멈춤 기능		●	●
재시동 보호장치		●	●
잔여 회전 브레이크		●	●
속도 설정		-	●
EPTA-Procedure 01:2014에 따른 중량 ^{C)}			
- 진동 방지용 보조 손잡이 포함	kg	2.5-3.5	2.5-3.5
- 보조 손잡이 포함	kg	2.3-3.3	2.3-3.3
충전 시 권장되는 주변 온도	°C	0 ... +35	0 ... +35
작동 시 ^{D)} 및 보관 시 허용되는 주변 온도	°C	-20 ... +50	-20 ... +50
호환 가능한 배터리		GBA 18V... ProCORE18V...	GBA 18V... ProCORE18V...
전출력 발휘를 위해 권장하는 배터리		ProCORE18V... ≥ 5.5 Ah	ProCORE18V... ≥ 5.5 Ah
권장하는 충전기		GAL 18... GAX 18... GAL 36...	GAL 18... GAX 18... GAL 36...
데이터 전송			
블루투스®		블루투스® 4.2 (Low Energy) ^{E)}	블루투스® 4.2 (Low Energy) ^{E)}
신호 간격	s	8	8
최대 신호 도달 범위 ^{F)}	m	30	30

A) EN 60745-2-3 규격에 따른 정격 회전속도

B) ProCORE18V 8.0Ah 배터리 장착 시 20-25 °C에서 측정되었으며, 배터리 충전상태 및 기기의 작동 온도에 따라 달라질 수 있음

C) 사용하는 배터리에 따라 상이

D) 온도 <0 °C일 때 출력 제한

E) 모바일 단말기는 Bluetooth®-Low-Energy-장치(버전 4.2)와 호환되어야 하며, 일반 접근 프로파일(Generic Access Profile, GAP)을 지원해야 합니다.

F) 도달 범위는 사용하는 수신기를 비롯한 외부 조건에 따라 큰 차이가 있을 수 있습니다. 폐쇄된 공간에서 사용하거나 금속 장애물(예: 벽, 선반, 케이스 등)을 통과하는 경우 블루투스® 도달 범위가 현저하게 줄어든 수 있습니다.

조립

Bluetooth® Low Energy Module GCY 42 삽입하기

지침: 전동공구 GWS 18V-15 C의 경우 Bluetooth® Low Energy Module GCY 42가 액세서리로 제공되며, 전동공구 GWS 18V-15 SC의 경우 공급 품목에 포함되어 있습니다.

블루투스® Low Energy Module **GCY 42** 관련 정보는 해당 사용 설명서를 참조하십시오.

배터리 충전하기

▶ 기술자료에 기재되어 있는 충전기만 사용하십시오. 귀하의 전동공구에 사용된 리튬이온 배터리에 맞춰진 충전기들입니다.

지침: 배터리는 일부 충전되어 공급됩니다. 배터리의 성능을 완전하게 보장하기 위해서는 처음 사용하기 전에 배터리를 충전기에 완전히 충전하십시오. 리튬이온 배터리는 항상 충전할 수 있으며, 이로 인해 수명이 단축되지 않습니다. 충전을 하다 중간에 중지해도 배터리가 손상되지 않습니다.

리튬 이온 배터리는 “Electronic Cell Protection (ECP)” (전자 셀 보호) 기능이 있어 과도하게 방전 되지 않습니다. 배터리가 방전되면 안전 스위치가 작동하여 전동공구가 꺼지고 비트가 더 이상 움직이지 않습니다.

▶ 전동공구가 자동으로 작동이 중단된 경우 전원 스위치를 계속 누르지 마십시오. 배터리가 손상될 수 있습니다.

폐기처리에 관련된 지시 사항을 준수하십시오.

배터리 분리하기

배터리 (7) 는 배터리 해제 버튼 (8) 이 실수로 눌러져 배터리가 빠지는 것을 방지하기 위해 잠금장치가 이중으로 되어 있습니다. 전동공구에 배터리가 끼워져 있는 동안 배터리는 스프링으로 제 위치에 고정됩니다.

배터리 (7) 를 분리하려면 배터리 해제 버튼 (8) 을 누른 상태에서 배터리를 전동공구 측면으로 당겨내십시오. 무리하게 힘을 가하지 마십시오.

배터리 충전상태 표시기

배터리 충전상태 표시기에 있는 녹색 LED는 배터리의 충전 상태를 나타냅니다. 안전상의 이유로 전동공구가 멈춰 있는 경우에만 잔량상태 확인이 가능합니다.

충전상태 표시기 버튼 (9) 또는 (10) 을 누르면, 충전상태가 표시됩니다. 배터리가 분리된 상태에서도 표시 가능합니다.

충전상태 표시기 버튼을 눌렀는데도 LED가 켜지지 않으면 배터리가 손상된 것이므로 교환해 주어야 합니다.

지침: 배터리 충전 상태는 사용자 인터페이스 (4) 에도 표시됩니다 (참조 „상태 표시“, 페이지 44).

배터리 형식 GBA 18V...



LED	용량
연속등 3× 녹색	60-100 %
연속등 2× 녹색	30-60 %
연속등 1× 녹색	5-30 %
점멸등 1× 녹색	0-5 %

배터리 형식 ProCORE18V...



LED	용량
연속등 5× 녹색	80-100 %
연속등 4× 녹색	60-80 %
연속등 3× 녹색	40-60 %
연속등 2× 녹색	20-40 %
연속등 1× 녹색	5-20 %

LED	용량
점멸등 1× 녹색	0-5 %

보호 장비 조립하기

▶ 전동공구에 각종 작업(보수 정비 및 액세서리 교환 등)을 하거나 전동공구를 운반하거나 보관할 경우 배터리를 전동공구에서 빼십시오. 실수로 전원 스위치가 작동하게 되면 상해를 입을 위험이 있습니다.

지침기기가 작동 중에 연마석이 깨지거나 안전반이나 전동공구에 있는 홀더 장치가 손상된 경우 전동공구를 즉시 고객 서비스 센터에 보내야 합니다, "AS 센터 및 사용 문의" 단락에 나온 주소 참조.

연마작업용 안전반

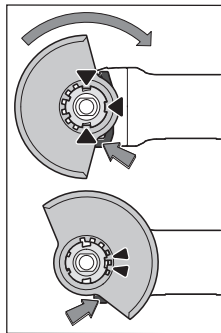

안전반의 코딩 홈과 홀더가 일치하도록 안전반 (10) 을 전동공구의 홀더에 끼우십시오. 이때 해제 레버 (1) 를 누르고 계십시오.

안전반의 끝이 전동공구 플랜지에 맞을 때까지 안전반 (10) 을 스프링 칼라 위로 누르고, 확실히 걸리는 소리가 날 때까지 안전반을 돌립니다.

작업에 필요한 상태로 안전반 (10) 의 위치를 조절하십시오. 이때 해제

레버 (1) 를 위로 누른 상태로 안전반 (10) 을 원하는 위치로 돌립니다.

▶ 항상 안전반 해제 레버 (10) 양쪽 홈 전체가 안전반 (1) 의 해당 홈에 맞물리도록 안전반 (10) 을 맞춥니다.

▶ 안전반 (10) 을 작업자에게 스파크가 튀지 않도록 맞춥니다.

▶ 안전반 (10) 은 해제 레버 (1) 를 누른 상태에서만 돌릴 수 있게 되어 있습니다! 그렇지 않으면 절대로 전동공구를 계속 사용해서는 안 되며 서비스 센터에 보내야 합니다.

지침: 안전반 (10) 에 있는 코딩 홈에 따라 전동공구 모델에 맞는 안전반만 조립할 수 있게 되어 있습니다.

절단작업용 안전반

▶ 절단석을 이용한 절단 시에는 항상 절단작업용 안전반을 사용해야 합니다(15).

▶ 석재 절단 시에는 분진 추출장치가 설치되어 있어야 합니다.

절단작업용 안전반 (15) 의 조립은 연마작업용 안전반 (10) 을 조립하는 것과 같습니다.

보조 손잡이

▶ 반드시 보조 손잡이를 장착하여 전동공구를 사용하십시오 (9).

보조 손잡이 (9) 는 작업 방법에 따라 기어 헤드의 오른쪽이나 왼쪽에 장착할 수 있습니다.

진동 감소기능이 있는 보조 손잡이



진동 감소기능이 있는 보조 손잡이가 있어 진동을 감소하므로 작업이 수월하고 안전합니다.

다.

- ▶ 보조 손잡이에 어떠한 변화도 주어서는 안 됩니다.

손상된 보조 손잡이를 계속 사용하지 마십시오.

손 보호대

- ▶ 고무판 (20) 이나 컵 브러시/디스크 브러시/팬 그라인딩 디스크를 사용해 작업할 때는 반드시 손 보호대를 장착하십시오(19).

손 보호대(19)를 보조 손잡이 (9) 와 함께 고정시킵니다.

연마공구 조립하기

- ▶ 전동공구에 각종 작업(보수 정비 및 액세서리 교환 등)을 하거나 전동공구를 운반하거나 보관할 경우 배터리를 전동공구에서 빼십시오. 실수로 전원 스위치가 작동하게 되면 상해를 입을 위험이 있습니다.

- ▶ 완전히 식을 때까지 연마석이나 절단석을 만지지 마십시오. 작업 시 매우 뜨거워지기 때문입니다.

연삭 스펀들 (18) 의 기타 조립할 부품을 모두 깨끗이 닦습니다.

연마공구를 조이거나 풀려면, 스펀들 잠금 버튼 (3) 을 눌러 연삭 스펀들을 잠급니다.

- ▶ 스펀들 잠금 버튼은 연삭 스펀들이 완전히 정지된 상태에서만 작동하십시오. 그렇게 하지 않으면 전동공구가 손상될 수 있습니다.

연마석/절단석

연마공구의 치수를 확인하십시오. 구멍의 지름은 사용 플랜지에 정확히 맞아야 합니다. 변형 조각이나 어댑터를 사용해서는 안 됩니다.

다이아몬드 절단석을 사용할 경우, 다이아몬드 절단석의 회전 방향 화살표와 전동공구의 회전 방향이 일치해야 하는 것에 주의하십시오(기어 헤드의 회전 방향 화살표 참조).

조립 순서는 도면에 나와 있습니다.

연마석/절단석을 고정하려면 클램핑 너트 (13) 를 끼우고 양구 스페너로 조입니다.

- ▶ 연마석을 조립하고 나서 전원 스위치를 켜기 전에 연마석이 제대로 조립되어 있는지 장애 없이 잘 돌아가는지 확인하십시오. 연마석이 안전반이나 다른 부위에 닿지 않도록 해야 합니다.

팬 그라인딩 디스크

- ▶ 팬 그라인딩 디스크를 사용해 작업할 때는 반드시 손 보호대를 장착하십시오 (19).

샌딩 페이퍼용 고무판

- ▶ 고무판 (20) 을 사용해 작업할 때는 반드시 손 보호대를 장착하십시오(19).

조립 순서는 .

고무판 (20) 을 연삭 스펀들 (18) 에 끼웁니다.

샌딩 페이퍼 (21) 를 고무 샌딩판 (20) 의 아랫면에 대고 누릅니다.

원형 너트 (22) 에 끼우고 투핀 스페너로 조입니다.

컵 브러시/디스크 브러시

- ▶ 컵 브러시나 디스크 브러시를 사용해 작업할 때는 반드시 손 보호대를 장착하십시오 (19).

조립 순서는 .

컵 브러시/디스크 브러시는 연삭 스펀들 나사산 끝에 있는 연삭 스펀들 플랜지에 바짝 닿도록 연삭 스펀들에 꼭 조여야 합니다. 컵 브러시와 디스크 브러시는 양구 스페너로 조입니다.

카바이드 컵 휠

- ▶ 컵 휠을 사용할 경우에는 반드시 적합한 안전반을 함께 사용해야 합니다.

허용 연마공구

이 사용 설명서에 나와 있는 모든 연마공구를 사용할 수 있습니다.

사용된 연마공구의 허용 속도 [min^{-1}]와 원주 속도 [m/s]는 적어도 다음의 도표에 나와 있는 수치와 일치해야 합니다.

그러므로 항상 사용하는 연마공구의 레벨에 나와 있는 허용 속도와 원주 속도를 확인하십시오.

	최대 [mm]				
	D	b	d	$[\text{min}^{-1}]$	$[\text{m/s}]$
	100	7	16	11000	80
	100	-	-	11000	80
	75	30	M 14	11000	45
	82	-	M 14	11000	80

기어 헤드 돌리기(GWS 18V-15 C)

- ▶ 전동공구에 각종 작업(보수 정비 및 액세서리 교환 등)을 하거나 전동공구를 운반하거나 보관할 경우 배터리를 전동공구에서 빼십시오. 실수로 전원 스위치가 작동하게 되면 상해를 입을 위험이 있습니다.

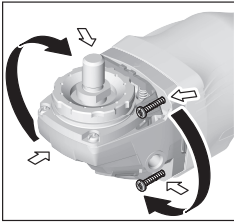

기어 헤드는 90° 간격으로 돌릴 수 있습니다. 특수한 작업을 할 경우 기어 헤드를 돌려 전원 스위치를 기기 조작이 수월한 위치로 움직일 수 있습니다. 예를 들면 왼손잡이 작업자에게 유리합니다.

4개의 나사를 완전히 풀어 줍니다. 기어 헤드를 조심스럽게 하우징에서 빼지 않은 상태에서 새로운 위치로 돌립니다. 4개의 나사를 다시 조입니다.

분진 및 톱밥 추출장치

납 성분을 포함한 페인트나 몇몇 나무 종류, 또는 광물 성분 그리고 철과 같은 재료의 분진은 건강을 해칠 수 있습니다. 이 분진을 만지거나 호흡할 경우, 사용자나 주변 사람들은 알레르기 반응이나 호흡기 장애를 일으킬 수 있습니다.

떡갈나무나 너도밤나무와 같은 특정한 분진은 암을 유발시키며, 특히 목재 처리용으로 사용되는 부가 원료(크로마트, 목재 보호제)와 혼합되면 암을 유발시키게 됩니다. 석면 성분을 포함한 재료는 오직 전문가가 작업을 해야 합니다.

- 작업장의 통풍이 잘 되도록 하십시오.
- 필터등급 P2에 해당되는 호흡 마스크를 사용하십시오.

작업용 재료에 관해 국가가 지정한 규정을 고려하십시오.

▶ **작업장에 분진이 쌓이지 않도록 하십시오.** 분진이 쉽게 발화할 수 있습니다.

작동

기계 시동

배터리 장착하기

배터리가 안전하게 고정될 때까지 충전한 배터리 (7) 를 앞쪽에서 전동공구의 다리쪽으로 미십시오.

전원 스위치 작동

전동공구를 작동하려면 전원 스위치 (5) 를 앞쪽으로 미십시오.

회전속도 사전 조절 선택(GWS 18V-15 SC)

초기 설정에서는 3가지 회전속도 단계가 사전 설정되어 있습니다. 특정 애플리케이션(보쉬 Toolbox 앱)을 통해 최대 6개의 회전속도 단계를 프로그래밍할 수 있습니다.

회전속도 단계의 개수가 변경되면, 사전 설정되었던 개별 단계의 값이 바뀝니다. 이 경우 회전속도 단계/모드 표시기 (28) 가 흰색으로 점등됩니다. 회전속도 값이 개별적으로 프로그래밍된 경우, 해당 회전속도 단계에서 회전속도 단계/모드 표시기 (28) 가 청색으로 점등됩니다(즉, 기본 설정과 달립니다). 회전속도 단계는 200 min⁻¹씩 변경할 수 있습니다. 이때 단계를 높여가는 것에 유의하십시오(2 ≥ 1 / 3 ≥ 2 등).

다음 표는 프로그래밍된 단계의 각 숫자에 해당되는 사전 설정된 회전속도(기본 설정)를 나타냅니다.

전원 스위치 (5) 를 잠금 상태로 유지하려면 전원 스위치 (5) 가 맞물려 고정될 때까지 더 앞으로 미니다.

전동공구의 전원을 끄려면, 전원 스위치 (5) 에서 손을 떼거나 전원 스위치가 잠겨 있는 경우, 전원 스위치 (5) 를 잠깐 뒤쪽 아래로 눌렀다가 손을 뺍니다.

▶ **기기를 사용하기 전 연마공구를 점검하십시오.** 연마공구는 아무런 이상 없이 장착되어서 잘 돌아가야 합니다. 최소한 1분간 무부하 상태로 시험 가동하십시오. 손상되었거나 원형이 아닌 진동하는 연마공구는 사용하지 마십시오. 손상된 연마공구는 파손되어 이로 인해 상해를 입을 수 있습니다.

급반동 멈춤 기능



절단 부위에서 블로킹이 일어나는 등 급반동이 있을 경우 모터로의 전류 공급이 중단될 수 있습니다. 이때 급반동 멈춤 기능 표시기 (26) 가 점등됩니다. 급반동 멈춤 기능이 작동되고 있는 경우 상태 표시기 (30) 는 적색으로 깜박입니다.

전동공구를 다시 작동하려면 전원 스위치 (5) 를 꺼짐 위치로 돌린 후에 다시 스위치를 켜십시오.

재시동 보호장치

재시동 보호장치는 전원이 차단되었다가 다시 들어온 경우 전동공구가 임의로 다시 작동하는 것을 방지합니다.

재작동 보호 장치가 작동되고 있는 경우 상태 표시기 (30) 는 적색으로 깜박입니다.

전동공구를 다시 작동하려면 전원 스위치 (5) 를 꺼짐 위치로 돌린 후에 다시 스위치를 켜십시오.

충돌 차단장치

충돌 차단장치가 내장되어 있어 전동공구가 바닥에 떨어지면 바로 전동공구가 꺼집니다. 이 경우 상태 표시기 (30) 는 적색으로 깜박입니다.

전동공구를 다시 작동하려면 전원 스위치 (5) 를 꺼짐 위치로 돌린 후에 다시 스위치를 켜십시오.

사용자 인터페이스(그림 A 참조)

사용자 인터페이스 (4) 는 전동공구의 회전속도 사전 선택 및 상태 표시 용도로 사용됩니다.

44 | 한국어

GWS 18V-15 SC	단계별 회전속도 기본 설정					
	1	2	3	4	5	6
	[min ⁻¹]	[min ⁻¹]	[min ⁻¹]	[min ⁻¹]	[min ⁻¹]	[min ⁻¹]
회전속도 단계 숫자						
1	3400	-	-	-	-	-
2	3400	9800	-	-	-	-
3	3400	6600	9800	-	-	-
4	3400	5600	7600	9800	-	-
5	3400	5000	6600	8200	9800	-
6	3400	4600	6000	7200	8600	9800

제시된 회전속도 단계 값은 사용하는 배터리, 배터리의 충전상태 및 기기의 작동 온도에 따라 달라질 수 있습니다.

작동 중에도 회전속도 사전 선택 버튼 (27) 을 눌러 요구되는 회전속도를 사전 선택할 수 있습니다. 다음의 표에 나온 자료는 3개 회전속도가 사전 설정된 초기 설정에 대한 권장 수치입니다.

소재	사용 분야	비트	회전속도 사전 조절 단계	GWS 18V-15 SC [min ⁻¹]
금속	브러싱 작업, 녹제거 작업	와이어 컵 브러시	1	3400
스테인리스 스틸	연마 작업	섬유 디스크	2	6600
금속	연마 작업	연마석	3	max
금속	절단 작업	연마석	3	max
석재	절단 작업	다이아몬드 절단석 및 절단 가이드(석재 절단 시에는 절단 가이드만 이용 가능)	3	max

▶ 액세서리의 정격 속도는 적어도 공구에 표시되어 있는 최고 속도와 동일해야 합니다. 정격 속도보다 빠르게 작동되는 액세서리는 파손되어 분리될 수 있습니다.

상태 표시

배터리 충전 상태 표시기 (사용자 인터페이스) (25)	의미/원인	해결책
--------------------------------	-------	-----

녹색	배터리 충전됨	-
황색	배터리 거의 방전됨	배터리를 금방 교체하거나 충전하십시오.
적색	배터리가 비어 있음	배터리를 교체하거나 충전하십시오.

온도 표시기 (31)	의미/원인	해결책
-------------	-------	-----

황색	임계 수준의 온도에 도달함(모터, 전자 시스템, 배터리)	전동공구를 공회전 상태로 작동시킨 후 식히십시오.
적색	전동공구가 과열되어 전원 꺼짐	전동공구를 식히십시오.

전동공구 상태 표시기 (30)	의미/원인	해결책
------------------	-------	-----

녹색	상태 양호함	-
황색	임계 수준의 온도에 도달했거나 배터리가 거의 방전됨	전동공구를 공회전 상태로 작동시킨 후 식히거나 배터리를 금방 교체 또는 충전시키십시오.
적색으로 점등됨	전동공구가 과열되었거나 배터리 방전됨	전동공구를 식히거나 배터리를 교체 또는 충전시키십시오.

전동공구 상태 표시기 (30)	의미/원인	해결책
적색으로 깜박임	급반동 차단장치, 재작동 방지 보호 장치 또는 충돌 차단장치가 작동됨	전동공구를 꺾다가 다시 켜십시오.
청색 깜박임	전동공구가 모바일 단말기와 연결되어 있거나 설정 내역이 전송되고 있음	-

연결 기능

블루투스® Low Energy Module **GCY 42** 을 결합하면 전동공구에 다음과 같은 연결 기능이 제공됩니다:

- 등록 및 사용자 개별화
- 상태 점검, 경고 메시지 출력
- 일반 정보 및 설정 내역
- 관리

블루투스® Low Energy Module **GCY 42** 관련 정보는 해당 사용 설명서를 참조하십시오.

전동공구를 앱에 연결하려면 사용자 인터페이스 (4) 에서 회전속도 사전 선택 버튼 (27) 을 눌러 승인해야 합니다. 연결 시 앱에서 승인을 요청합니다.

사용방법

- ▶ Bluetooth® Low Energy Module **GCY 42** 가 장착된 전동공구에는 무선 인터페이스가 갖춰져 있습니다. 비행기나 병원 등 장소에 따른 제약에 주의하십시오.
 - ▶ Bluetooth®-무선 기술 사용이 금지된 곳에서는 Bluetooth® Low Energy Module **GCY 42** 및 동전형 배터리를 분리해야 합니다.
 - ▶ 건물 벽면에 흠을 내는 작업을 할 때 주의, 구조에 관한 정보 참조.
 - ▶ 작업물이 자체의 중량으로 위치가 안정되어 있지 않으면 고정시켜야 합니다.
 - ▶ 전동공구에 무리하게 힘을 가하면 자동으로 작동이 중단됩니다.
 - ▶ 강한 부하 상태로 작업한 후에 전동공구를 몇 분간 무부하 상태로 돌아가게 하여 기기를 식혀 주십시오.
 - ▶ 전동공구를 그라인더 스탠드와 함께 사용하지 마십시오.
 - ▶ 완전히 식을 때까지 연마석이나 절단석을 만지지 마십시오. 작업 시 매우 뜨거워지기 때문입니다.
- 전동공구에 정전기가 일어나면 내장된 전자 제어장치가 전동공구의 작동을 멈추게 합니다. 전동공구를 재작동하려면 전원 스위치 (5) 를 다시 누르십시오.

연마작업

- ▶ 절대로 절단석을 연마용으로 사용해서는 안됩니다.
- 연마작업 시 접근 각도를 30° 에서 40° 로 하면 작업 결과가 아주 좋습니다. 전동공구를 적당한 힘으로 앞뒤로 움직이십시오. 이로써 작업물이 과열되지 않고, 탈색되지 않으며, 패이지도 않습니다.

팬 그라인딩 디스크

팬 그라인딩 디스크(별매 액세서리)를 사용하면 또한 곡면이나 측면에도 작업할 수 있습니다. 팬 그라인딩 디스크는 기존의 연마석에 비해 훨씬 수명이 길고 소음이 적으며 연마 온도도 낮습니다.

금속 절단작업

▶ 절단석을 이용한 절단 시에는 항상 절단작업용 안전반을 사용해야 합니다(15).

절단작업을 할 때 작업하려는 소재에 맞게 적당한 힘으로 앞으로 밀어 작업하십시오. 절단석에 무리하게 힘을 가하지 말고 비스듬히 기울이거나 진동해서 는 안됩니다.

잔여 회전을 하고 있는 절단석을 측면에서 압력을 가해 정지해서는 안됩니다.

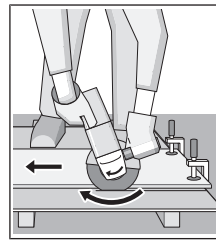

전동공구는 항상 회전 반대 방향으로 작업해야 합니다. 그렇지 않으면 절단선에서 저절로 벗어날 위험이 있습니다.

측면과 사각강을 절단할 때 가장 작은 모서리에서 시작하는 것이 가장 좋습니다.

석재 절단작업

- ▶ 석재 절단 시에는 분진 추출장치가 설치되어 있어야 합니다.
- ▶ 분진 마스크를 착용하십시오.
- ▶ 이 전동공구는 건식 절단/건식 연마를 하는 데에만 사용해야 합니다.

석재를 절단할 경우 다이아몬드 절단석을 사용하는 것이 좋습니다.

자갈이 많이 들어있는 콘크리트 등 특히 경도가 높은 작업 소재에 절단작업을 할 때 다이아몬드 절단석이 과열되어 손상될 수 있습니다. 이때 다이아몬드 절단석이 회전하며 불꽃이 생깁니다.

이러한 경우 절단작업을 중지하고 다이아몬드 절단석을 무부하 상태로 최고 속도로 잠시 공회전시키며 냉각시킵니다.

작업 속도가 현저하게 늦어지고 회전하는 불꽃이 생기면 다이아몬드 절단석이 무디어진 것을 의미합니다. 이 경우 석회질 사람 등의 연마재에 잠깐 갈아주면 다시 날카로워 집니다.

구조에 관한 정보

들보 벽에 흠을 파는 작업을 할 때 DIN 규격 1053/1항이나 각국의 규정에 맞게 작업해야 합니다. 이 규정은 반드시 준수해야 합니다. 작업을 시작

하기 전에 담당 건축가나 건설 책임자와 상의하십시오.

올바른 배터리의 취급 방법

배터리를 습기나 물이 있는 곳에 두지 마십시오.
배터리를 -20 °C 에서 50 °C 온도 범위에서만 저장하십시오. 예를 들면 배터리를 여름에 자동차 안에 두지 마십시오.
가끔 배터리의 통풍구를 부드럽고 깨끗한 마른 솔로 청소하십시오.
충전 후 작동 시간이 현저하게 짧아지면 배터리의 수명이 다한 것이므로 배터리를 교환해야 합니다.
처리에 관련된 지시 사항을 준수하십시오.

보수 정비 및 서비스

보수 정비 및 유지

- ▶ 전동공구에 각종 작업(보수 정비 및 액세서리 교환 등)을 하거나 전동공구를 운반하거나 보관할 경우 배터리를 전동공구에서 빼십시오. 실수로 전원 스위치가 작동하게 되면 상해를 입을 위험이 있습니다.
- ▶ 안전하고 올바른 작동을 위하여 전동공구와 전동공구의 통풍구를 항상 깨끗이 하십시오.
액세서리를 조심스럽게 취급하고 보관하십시오.

AS 센터 및 사용 문의

AS 센터에서는 귀하 제품의 수리 및 보수정비, 그리고 부품에 관한 문의를 받고 있습니다. 대체 부품에 관한 분해 조립도 및 정보는 인터넷에서도 찾아볼 수 있습니다 - www.bosch-pt.com
보수 사용 문의 팀에서는 보수의 제품 및 해당 액세서리에 관한 질문에 가까이 답변 드릴 것입니다.
문의나 대체 부품 주문 시에는 반드시 제품 네임 플레이트에 있는 10자리의 부품번호를 알려 주십시오.
콜센터
080-955-0909

다른 AS 센터 주소는 아래 사이트에서 확인할 수 있습니다:

www.bosch-pt.com/serviceaddresses

운반

포함되어 있는 리튬이온 배터리는 위험물 관련 규정을 따라야 합니다. 별도의 요구사항 없이 배터리를 사용자가 직접 도로 상에서 운반할 수 있습니다.
제3자를 통해 운반할 경우(항공 운송이나 운송 회사 등) 포장과 표기에 관한 특별한 요구 사항을 준수해야 합니다. 이 경우 발송 준비를 위해 위험물 전문가와 상담해야 합니다.
표면이 손상되지 않은 배터리만 사용하십시오. 배터리의 접촉 단자면을 덮어 불인 상태로 내부에서 움직이지 않도록 배터리를 포장하십시오. 또한 이와 관련한 국내 규정을 준수하십시오.

처리



전동공구, 배터리, 액세서리 및 포장은 환경 친화적인 방법으로 재활용 수 있도록 분류하십시오.



전동공구와 충전용 배터리/배터리를 가정용 쓰레기로 처리하지 마십시오!

충전용 배터리/배터리:

리튬이온:

운반 단락에 나와 있는 지침을 참고하십시오 (참조 "운반", 페이지 46).

ไทย

คำเตือนเพื่อความปลอดภัย

คำเตือนเพื่อความปลอดภัยทั่วไปในการใช้เครื่องมือไฟฟ้า

คำเตือน

อ่านคำเตือนเพื่อความปลอดภัยและคำสั่งทั้งหมด การไม่ปฏิบัติตามคำ

เตือนและคำสั่งอาจเป็นสาเหตุให้ถูกไฟฟ้าดูด เกิดไฟไหม้ และ/หรือได้รับบาดเจ็บอย่างร้ายแรง

เก็บรักษาคำเตือนและคำสั่งทั้งหมดสำหรับเปิดอ่านในภายหลัง

คำว่า "เครื่องมือไฟฟ้า" ในคำเตือนหมายถึง เครื่องมือไฟฟ้าของทำงานที่ทำงานด้วยพลังงานไฟฟ้าจากแหล่งจ่ายไฟหลัก (มีสายไฟฟ้า) และเครื่องมือไฟฟ้าที่ทำงานด้วยพลังงานไฟฟ้าจากแบตเตอรี่ (ไร้สาย)

ความปลอดภัยในสถานที่ทำงาน

- ▶ รักษาสถานที่ทำงานให้สะอาดและมีไฟส่องสว่างดี สถานที่ที่มีมืดหรือกรงรังนำมาซึ่งอุบัติเหตุ
- ▶ อย่าใช้เครื่องมือไฟฟ้าทำงานในสภาพบรรยากาศที่จุดติดไฟได้ เช่น ในพื้นที่ที่มีของเหลวไวไฟ ก๊าซ หรือฝุ่น เมื่อใช้เครื่องมือไฟฟ้าจะเกิดประกายไฟซึ่งอาจจุดฝุ่นหรือไอให้ลุกเป็นไฟได้
- ▶ ขณะใช้เครื่องมือไฟฟ้าทำงาน ต้องกันเด็กและผู้ยืนดูให้ออกห่าง การหันเหความสนใจอาจทำให้ท่านขาดการควบคุมเครื่องมือ

ความปลอดภัยเกี่ยวกับไฟฟ้า

- ▶ **ปลั๊กของเครื่องมือไฟฟ้าต้องเหมาะสมพอดีกับเต้าเสียบ** อย่าตัดแปลงปลั๊กไม่ว่าในลักษณะใดๆ อย่างเด็ดขาด อย่าใช้ปลั๊กพ่วงต่อใดๆ กับเครื่องมือไฟฟ้าที่มีสายดิน ปลั๊กที่ไม่ตัดแปลงและเต้าเสียบที่เข้ากันช่วยลดความเสี่ยงจากการถูกไฟฟ้าดูด
- ▶ **หลีกเลี่ยงอย่าให้ร่างกายสัมผัสกับพื้นผิวที่ต่อสายดินหรือลงกราวด์ไว้** เช่น ท่อ เครื่องทำความร้อน เตา และตู้เย็น จะเสี่ยงอันตรายจากการถูกไฟฟ้าดูดมากขึ้นหากกระแสไฟฟ้าวิ่งผ่านร่างกายของท่านลงดิน
- ▶ **อย่าให้เครื่องมือไฟฟ้าถูกฝนหรืออยู่ในสภาพเปียกชื้น** หากน้ำเข้าในเครื่องมือไฟฟ้า จะเพิ่มความเสี่ยงจากการถูกไฟฟ้าดูด
- ▶ **อย่าใช้สายไฟฟ้าในทางที่ผิด** อย่าใช้สายไฟฟ้าเพื่อยก ding หรือถอดปลั๊กเครื่องมือไฟฟ้า กันสายไฟฟ้าออกจากทางจากความร้อน น้ำมัน ขอบแหลมคม หรือชิ้นส่วนที่เคลื่อนที่ สายไฟฟ้าที่ชำรุดหรือพันกันยุ่งเพิ่มความเสี่ยงจากการถูกไฟฟ้าดูด
- ▶ **เมื่อใช้เครื่องมือไฟฟ้าทำงานกลางแจ้ง ให้ใช้สายไฟ** ต่อที่เหมาะสมสำหรับงานกลางแจ้งช่วยลดอันตรายจากการถูกไฟฟ้าดูด
- ▶ **หากไม่สามารถหลีกเลี่ยงการใช้เครื่องมือไฟฟ้าทำงาน** ในสถานที่เปียกชื้นได้ ให้ใช้สวิตช์ตัดวงจรเมื่อเกิดการรั่วไหลของไฟฟ้าจากสายดิน (RCD) การใช้สวิตช์ตัดวงจรเมื่อเกิดการรั่วไหลของไฟฟ้าจากสายดินช่วยลดความเสี่ยงต่อการถูกไฟฟ้าดูด

ความปลอดภัยของบุคคล

- ▶ **ท่านต้องอยู่ในสภาพเตรียมพร้อม** ระมัดระวังในสิ่งที่ท่านกำลังทำอยู่ และมีสติขณะใช้เครื่องมือไฟฟ้าทำงาน อย่าใช้เครื่องมือไฟฟ้าขณะที่ท่านกำลังเหนื่อยหรืออยู่ภายใต้การครอบงำของฤทธิ์ของยาเสพติด แอลกอฮอล์ และยา เมื่อใช้เครื่องมือไฟฟ้าทำงานในชั่วโมงที่ท่านขาดความเอาใจใส่อาจทำให้บุคคลบาดเจ็บอย่างรุนแรงได้
- ▶ **ใช้อุปกรณ์ปกป้องร่างกาย** สวมแว่นตาป้องกันเสมอ อุปกรณ์ปกป้อง เช่น หน้ากากกันฝุ่น รองเท้ากันลื่น หมวกแข็ง หรือประคบทุกชิ้นเสียงดัง ที่เลือกใช้ตามความเหมาะสมกับสภาพการทำงาน สามารถลดอันตรายต่อบุคคลได้
- ▶ **ป้องกันการติดเครื่องโดยไม่ตั้งใจ** ตรวจสอบให้แน่ใจว่าสวิตช์อยู่ในตำแหน่งปิดก่อนเชื่อมต่อเข้ากับแหล่งจ่ายไฟ และ/หรือเบรกเกอร์แพ็ค ยกหรือถือเครื่องมือ

- การถือเครื่องโดยไขว้นิ้วที่สวิตช์ หรือเสียบปลั๊กไฟฟ้าขณะสวิตช์เปิดอยู่ อาจนำไปสู่อุบัติเหตุที่ร้ายแรงได้
- ▶ **นำเครื่องมือปรับแต่งหรือประแจปากค้ายออกก่อนเปิด** สวิตช์เครื่องมือไฟฟ้า เครื่องมือหรือประแจปากค้ายที่วางอยู่กับส่วนของเครื่องที่กำลังหมุนจะทำให้บุคคลบาดเจ็บได้
- ▶ **อย่าเอื้อมไกลเกินไป** ตั้งทำยี่ห้อที่มั่นคงและวางน้ำหนักให้สมดุลตลอดเวลา ในลักษณะที่ท่านสามารถควบคุมเครื่องมือไฟฟ้าในสถานการณ์ที่ไม่คาดคิดได้ดีกว่า
- ▶ **แต่งกายอย่างเหมาะสม** อย่าใส่เสื้อผ้าหลวมหรือสวมเครื่องประดับ เอามงกุฎ เสื้อผ้า และถุงมือ ออกห่างจากชิ้นส่วนที่กำลังหมุน เสื้อผ้าหลวม เครื่องประดับ และผมยาวอาจเข้าไปติดในส่วนของเครื่องที่กำลังหมุนได้
- ▶ **หากเครื่องมือไฟฟ้ามีข้อเชื่อมต่อกับเครื่องดูดฝุ่นหรือเครื่องเก็บผง** ให้ตรวจสอบให้แน่ใจว่าได้เชื่อมต่อและใช้งานอย่างถูกต้อง การใช้อุปกรณ์ดูดฝุ่นช่วยลดอันตรายที่เกิดจากฝุ่นได้

การใช้และการดูแลรักษาเครื่องมือไฟฟ้า

- ▶ **อย่าฝืนกำลังเครื่องมือไฟฟ้า** ใช้เครื่องมือไฟฟ้าที่ถูกต้องตรงตามลักษณะงานของท่าน เครื่องมือไฟฟ้าที่ต้องจะทำงานได้ดีกว่าและปลอดภัยกว่าในระดับสมรรถภาพที่ออกแบบไว้
- ▶ **อย่าใช้เครื่องมือไฟฟ้าถ้าสวิตช์ไม่สามารถเปิดปิดได้** เครื่องมือไฟฟ้าที่ไม่สามารถควบคุมการเปิดปิดด้วยสวิตช์ได้ เป็นเครื่องมือไฟฟ้าที่ไม่ปลอดภัยและต้องส่งซ่อมแซม
- ▶ **ก่อนปรับแต่งเครื่อง** เปลี่ยนอุปกรณ์ประกอบ หรือเก็บเครื่องมือไฟฟ้าเข้าที่ ต้องถอดปลั๊กไฟออกจากแหล่งจ่ายไฟ และ/หรือถอดเบรกเกอร์แพ็คออกจากเครื่องมือไฟฟ้า มาตรการป้องกันเพื่อความปลอดภัยนี้ช่วยลดความเสี่ยงจากการติดเครื่องโดยไม่ตั้งใจ
- ▶ **เมื่อเลิกใช้งานเครื่องมือไฟฟ้า** ให้เก็บเครื่องมือไว้ในที่ที่เด็กหยิบไม่ถึง และไม่อนุญาตให้บุคคลที่ไม่คุ้นเคยกับเครื่องมือไฟฟ้าที่ไม่ได้อนุญาตให้นำเหล่านี้ใช้เครื่องมือไฟฟ้าเป็นของอันตรายหากตกอยู่ในมือของผู้ใช้ที่ไม่ได้รับการฝึกฝน
- ▶ **บำรุงรักษาเครื่องมือไฟฟ้า** ตรวจสอบชิ้นส่วนที่เคลื่อนที่ว่าวางไม่ตรงแนวหรือติดขัดหรือไม่ ตรวจสอบหาการแตกหักของชิ้นส่วนและสภาพอื่นใดที่อาจมีผลต่อการทำงานของเครื่องมือไฟฟ้า หากชำรุดต้องส่งเครื่องมือไฟฟ้าไปซ่อมแซมก่อนใช้งาน อุบัติเหตุหลายอย่างเกิดขึ้นเนื่องจากดูแลรักษาเครื่องมือไม่ดีพอ

- ▶ **รักษาเครื่องมือตัดให้คมและสะอาด**
หากบำรุงรักษาเครื่องมือที่มีขอบตัดแหลมคมอย่างถูกต้อง จะสามารถตัดได้ลื่นไม่ติดขัดและควบคุมได้ง่ายกว่า
- ▶ **ใช้เครื่องมือไฟฟ้า อุปกรณ์ประกอบ เครื่องมือ และอุปกรณ์อื่นๆ ตรงตามคำแนะนำเหล่านี้ โดยคำนึงถึงเงื่อนไขการทำงานและงานที่จะทำ** การใช้เครื่องมือไฟฟ้าทำงานที่ต่างไปจากวัตถุประสงค์การใช้งานของเครื่อง อาจนำไปสู่สถานการณ์ที่เป็นอันตรายได้

การใช้และการดูแลรักษาเครื่องมือใช้แบตเตอรี่

- ▶ **ชาร์จไฟใหม่ด้วยเครื่องชาร์จที่บริษัทผู้ผลิตระบุไว้เท่านั้น**
เครื่องชาร์จที่เหมาะสมสำหรับชาร์จแบตเตอรี่แพ็คเกจหนึ่ง หากนำไปชาร์จแบตเตอรี่แพ็คเกจอื่น อาจเกิดไฟไหม้ได้
- ▶ **ใช้เครื่องมือไฟฟ้าเฉพาะกับแบตเตอรี่แพ็คเกจที่กำหนดไว้เท่านั้น** การใช้แบตเตอรี่แพ็คเกจอื่นเสี่ยงต่อการเกิดไฟไหม้หรือบาดเจ็บ
- ▶ **เมื่อไม่ใช้งานแบตเตอรี่แพ็คเกจ ให้เก็บไว้ห่างวัตถุที่เป็นโลหะอื่นๆ เช่น คลิปหนีบกระดาษ เหยือก คุกกี้ เตปูลงกรู หรือวัตถุที่เป็นโลหะขนาดเล็กอื่นๆ ที่สามารถเชื่อมต่อขั้วหนึ่งไปยังอีกขั้วหนึ่งได้**
การลัดวงจรของขั้วแบตเตอรี่อาจทำให้เกิดการไหม้หรือไฟลุกได้
- ▶ **หากใช้แบตเตอรี่อย่างอาจมีของเหลวไหลออกมาจากแบตเตอรี่ได้ ให้หลีกเลี่ยงการสัมผัส หากสัมผัสโดยบังเอิญ ให้ใช้น้ำล้าง หากของเหลวเข้าตา ให้ขอความช่วยเหลือจากแพทย์ด้วย**
ของเหลวที่ไหลออกมาจากแบตเตอรี่อาจทำให้เกิดอาการคันหรือแสบผิวหนังได้

การบริการ

- ▶ **ส่งเครื่องมือไฟฟ้าของท่านเข้ารับบริการจากช่างซ่อมที่มีคุณสมบัติเหมาะสม โดยใช้อะไหล่ที่เหมือนกันเท่านั้น** ในลักษณะนี้ท่านจะแน่ใจได้ว่าเครื่องมือไฟฟ้าอยู่ในสภาพที่ปลอดภัย

คำแนะนำเพื่อความปลอดภัยสำหรับเครื่องขัดมุม

- ▶ **คำเตือนเพื่อความปลอดภัยทั่วไปสำหรับการเจียรใน การขัดด้วยกระดาษทราย การแปร่งด้วยลวด หรือการตัดแบบขัด**
- ▶ **เครื่องมือไฟฟ้านี้มีวัตถุประสงค์เพื่อการใช้งานเป็นเครื่องเจียร หรือเครื่องตัดออก อ่านคำเตือนเพื่อความปลอดภัย คำแนะนำ ภาพประกอบ และข้อมูลจำเพาะทั้งหมดที่จัดส่งมาพร้อมกับเครื่องมือไฟฟ้า การไม่ปฏิบัติตามคำแนะนำทั้งหมดที่ระบุไว้ด้านล่างนี้**

ล่างนี้อาจทำให้ถูกไฟฟ้าดูด เกิดไฟไหม้ และ/หรือได้รับบาดเจ็บอย่างรุนแรง

- ▶ **ไม่แนะนำให้ใช้เครื่องมือไฟฟ้าสำหรับงานขัดเงาเป็นต้น** หากใช้เครื่องทำงานที่ไม่ได้ถูกออกแบบมาสำหรับงานนั้นๆ อาจทำให้เกิดอันตรายและบาดเจ็บได้
- ▶ **อย่าใช้อุปกรณ์ประกอบที่ผู้ผลิตไม่ได้แนะนำให้ใช้ และไม่ได้ออกแบบไว้ให้ใช้เฉพาะกับเครื่องมือไฟฟ้านี้** ด้วยเหตุนี้เพราะท่านสามารถถอดอุปกรณ์ประกอบเข้ากับเครื่องมือไฟฟ้าของท่านได้ ก็มีได้เป็นการรับรองว่าอุปกรณ์ประกอบจะทำงานได้อย่างปลอดภัย
- ▶ **ความเร็ว**
รอบกำหนดของอุปกรณ์ประกอบต้องเท่ากับความเร็วรอบสูงสุดที่ระบุไว้บนเครื่องมือไฟฟ้าเป็นอย่างน้อย อุปกรณ์ประกอบที่หมุนเร็วกว่าความเร็วรอบกำหนดของตัวเองอาจแตกและกระเด็นออกเป็นชิ้นๆ
- ▶ **เส้นผ่าศูนย์กลางรอบนอกและความหนาของอุปกรณ์ประกอบของท่านต้องอยู่ในพิสัยความสามารถของเครื่องมือไฟฟ้าของท่าน**
อุปกรณ์ประกอบที่ผิดขนาดจะไม่สามารถปกป้องและควบคุมอย่างเพียงพอ
- ▶ **อุปกรณ์ประกอบที่ติดตั้งโดยการหมุนเกลียวต้องมีขนาดเกลียวที่เข้ากันพอดีกับเกลียวของแกนเครื่องเจียรสำหรับอุปกรณ์ประกอบที่ติดตั้งโดยใช้หน้าแปลน รูยึดของอุปกรณ์ประกอบต้องมีขนาดพอดีกับเส้นผ่าศูนย์กลางของหน้าแปลน** อุปกรณ์ประกอบที่ไม่เข้าคู่กับส่วนที่ใช้ยึดของเครื่องมือไฟฟ้า จะวิ่งไม่สมดุล สั่นตัวมาก และอาจทำให้สูญเสียการควบคุม
- ▶ **อย่าใช้อุปกรณ์ประกอบที่ชำรุด ตรวจสอบอุปกรณ์ประกอบก่อนใช้งานทุกครั้ง เช่น งานขัดให้ดูรอยบิ่นและรอยแตกร้าว แผ่นหมุนให้ดูรอยแตกร้าว รอยฉีกหรือรอยสึกหรอที่มากเกินไป แปร่งลวดให้ดูการโยกคลอนหรือการแตกหักของเส้นลวด หากเครื่องมือไฟฟ้าหรืออุปกรณ์ประกอบตกหล่น ให้ตรวจสอบความเสียหายหรือติดตั้งอุปกรณ์ประกอบที่ไม่ชำรุด หลังจากตรวจสอบและติดตั้งอุปกรณ์ประกอบแล้ว ตัวท่านเองและบุคคลที่อยู่ใกล้เคียงต้องอยู่ห่างจากระนาบของอุปกรณ์ประกอบที่หมุน และปล่อยเครื่องมือไฟฟ้าเดินตัวเปล่าที่ความเร็วสูงสุดนานหนึ่งนาที**
ตามปกติอุปกรณ์ประกอบที่ชำรุดจะแตกออกเป็นชิ้นๆ ในช่วงเวลาทดสอบนี้
- ▶ **สวมอุปกรณ์ป้องกันเฉพาะตัว ให้ใช้กระบังป้องกันหน้า แวนตาป้องกันลมและฝุ่น หรือแว่นตาป้องกันอันตรายโดยขึ้นอยู่กับลักษณะการทำงาน สวมหน้ากากกันฝุ่น ประคบหูกันเสียงดัง ลูมิเนียม**

และหากันเป็นสำหรับช่างที่สามารถกันผงขัดหรือเศษ ชิ้นงานขนาดเล็กตามความเหมาะสม

แว่นป้องกันตาต้องสามารถหยุดเศษผงที่ปลิว
ว่อนที่เกิดจากการทำงานแบบต่างๆ ได้
หน้ากากกันฝุ่นหรืออุปกรณ์ป้องกันระบบหายใจต้องสามารถ
กรองอนุภาคที่เกิดจากการทำงานของท่านได้
การได้ยินเสียงดังมากเป็นเวลานานอาจทำให้ท่านสูญเสียการได้ยิน

- ▶ **กันบุคคลที่อยู่ใกล้เคียงให้อยู่ในระยะปลอดภัยห่างจาก
บริเวณทำงาน บุคคลใดที่เขามายังบริเวณทำงานต้อง
สวมอุปกรณ์ป้องกันเฉพาะตัว** เศษวัสดุชิ้น
งานหรืออุปกรณ์ประกอบที่แตกหักอาจปลิวออกมา
และทำให้ได้รับบาดเจ็บนอกพื้นที่ปฏิบัติงานโดยตรง
- ▶ **เมื่อทำงานในบริเวณที่เครื่องมือตัดอาจสัมผัสสายไฟฟ้า
ที่ซ่อนอยู่ ต้องจับเครื่องมือไฟฟ้าตรงพื้นผิวจับที่หุ้ม
ฉนวนเท่านั้น** หากเครื่องมือตัดสัมผัสสายที่ “มีกระแส
ไฟฟ้า” ไหลผ่าน จะทำให้ชิ้นส่วนโลหะที่ไม่ได้หุ้มฉนวนของ
เครื่องมือไฟฟ้าเกิด “มีกระแสไฟฟ้า” ด้วย และส่งผลให้ผู้
ใช้งานเครื่องมือถูกไฟฟ้าดูดได้
- ▶ **อย่าวางเครื่องมือไฟฟ้าลงบนพื้นจนกว่าอุปกรณ์
ประกอบจะหยุดหมุนและนิ่งอยู่กับที่แล้ว**
อุปกรณ์ประกอบที่หมุนอยู่อาจเฉี่ยวถูกพื้นและกระชากเครื่อ
มือไฟฟ้าออกจากการควบคุมของท่าน
- ▶ **อย่าเปิดเครื่องมือไฟฟ้าทำงานขณะถือเครื่องไว้ข้างตัว**
เสื้อผ้าของท่านอาจเกี่ยว
พันกับอุปกรณ์ประกอบที่กำลังหมุนโดยไม่ตั้งใจ
และจุดอุปกรณ์ประกอบเข้าหาร่างกายของท่านได้
- ▶ **ทำความสะอาดช่องระบายอากาศของเครื่องมือไฟฟ้า
อย่างสม่ำเสมอ** พัดลมของมอเตอร์จะดูดผง
ฝุ่นเข้าไปในตัวเรือน และผงโลหะที่พอกสะสมกันมากเกินไป
ไปอาจทำให้เกิดอันตรายทางไฟฟ้าได้
- ▶ **อย่าใช้เครื่องมือไฟฟ้าทำงานใกล้วัตถุติดไฟได้**
ประกายไฟสามารถจุดวัสดุเหล่านี้ให้ลุกเป็นไฟ
- ▶ **อย่าใช้อุปกรณ์ประกอบที่ต้องใช้สารหล่อเย็นที่เป็น
ของเหลว** การใช้น้ำหรือสารหล่อเย็นอื่นๆ
ที่เป็นของเหลวอาจทำให้กระแสไฟฟ้าวิ่งผ่านเข้าตัวจนเสียชีวิตหรือถูกไฟฟ้าดูดได้

การตีกลับและคำเตือนเกี่ยวเนื่อง

การตีกลับคือแรงสะท้อนกะทันหันที่เกิดจากงานขัด แผ่นหมุน
แปร่ง และอุปกรณ์ประกอบอื่นใดเกิดบิดหรือถูกเหนี่ยว
รั้งขณะกำลังหมุน การบิดหรือการเหนี่ยว
รั้งทำให้อุปกรณ์ประกอบที่กำลังหมุนหยุดกะทันหัน ด้วยเหตุ
นี้เครื่องมือไฟฟ้าที่ขาดการควบคุมจึงถูกผลักไปในทิศทางตรง
กันข้ามกับการหมุนของอุปกรณ์ประกอบ ณ
จุดที่เกิดการติดขัด

ตัวอย่าง เช่น หากงานขัดถูกเหนี่ยวรั้งหรือบิดโดยชิ้นงาน
ขอบของงานขัดที่ติดอยู่ในจุดบิดอาจขูดเข้าไปในพื้นผิวของชิ้น
งาน ทำให้งานขัดเป็นออกหรือผลัดตัวออกมา งาน
ขัดอาจกระโดดเข้าหาหรือกระโดดออกจากผู้ใช้เครื่อง
ทั้งนี้ขึ้นอยู่กับทิศทางเคลื่อนที่ของงานขัด ณ จุดบิด
ในสถานการณ์เช่นนี้งานขัดอาจแตกหักได้ด้วยการ
ตีกลับเป็นผลจากการใช้เครื่องมือไฟฟ้าในทางที่ผิด และ/
หรือมีกระบวนการหรือเงื่อนไขการทำงานที่ไม่ถูกต้อง
และสามารถหลีกเลี่ยงได้ด้วยการป้องกันไว้ก่อนอย่างถูก
ต้องตั้งระบไว้ด้านล่างนี้

- ▶ **จับเครื่องมือไฟฟ้าให้แน่น และตั้งตัวและแขนของท่าน
ให้สามารถต้านแรงตีกลับได้** หากมีด้ามจับเพิ่ม ต้อง
ใช้ด้ามจับเพิ่มร่วมด้วยเสมอ ทั้งนี้เพื่อที่จะสามารถ
ควบคุมการตีกลับหรือกำลังสะท้อนจากแรงบิดขณะ
สตาร์ทเครื่องได้อย่างเต็มที่ ผู้
ใช้เครื่องสามารถควบคุมกำลังสะท้อนจากแรง
บิดหรือการตีกลับ หากใดระมัดระวังอย่างถูกต้องไว้ก่อน
- ▶ **อย่ายื่นมือของท่านเข้าใกล้อุปกรณ์ประกอบที่กำลังหมุน
อย่างเด็ดขาด** อุปกรณ์ประกอบอาจตี
กลับมาที่มือของท่านได้
- ▶ **อย่าให้ร่างกายของท่านอยู่ในบริเวณที่เครื่องมือไฟฟ้า
จะเคลื่อนเข้าหากเกิดการตีกลับ** การตี
กลับจะผลักเครื่องมือไฟฟ้าไปยังทิศทางตรงกัน
ข้ามกับการเคลื่อนที่ของงานขัด ณ จุดเหนี่ยวรั้ง
- ▶ **ใช้ความระมัดระวังเป็นพิเศษเมื่อทำงานบริเวณมุม ขอบ
แหลมคม ราว ป้องกันไม่ให้อุปกรณ์ประกอบกระเด็น
กลับจากชิ้นงานและติดขัด** มุม ขอบแหลมคม
และการกระเด็นกลับมักจะเหนี่ยว
รั้งอุปกรณ์ประกอบที่กำลังหมุน และทำให้สูญเสียการ
ควบคุมหรือทำให้เกิดการตีกลับ
- ▶ **อย่าประกอบใบเลื่อยโซ่แก๊สสลับไม้หรือใบเลื่อยแบบมี
ฟัน** ใบเลื่อยเหล่านี้ทำให้เกิดการตีกลับและสูญเสียการ
ควบคุมบ่อยครั้ง

คำเตือนเพื่อความปลอดภัยเฉพาะสำหรับการเจียรในและ
การตัดแบบขัด

- ▶ **ใช้เฉพาะงานประเภทที่แนะนำให้ใช้กับเครื่องมือไฟฟ้า
ของท่าน และกระบังป้องกันเฉพาะที่ออกแบบไว้สำหรับ
งานที่เลือกใช้นั้น** งานที่ไม่
ได้ออกแบบไว้สำหรับใช้กับเครื่องมือไฟฟ้าจะไม่
ได้รับการปกป้องอย่างเพียงพอและไม่ปลอดภัย
- ▶ **งานขัดศูนย์จุ่มควรติดตั้งในลักษณะที่พื้นผิวขัดจะต้อง
ไม่ยื่นออกมาจนกระนาบของขอบกระบังป้องกัน
งานที่ติดตั้งไม่ถูกต้องที่ยื่นละระนาบของขอบกระ
บังป้องกันจะไม่ได้รับการป้องกันอย่างเพียงพอ**

- ▶ **ต้องประกอบกระบังป้องกันเข้ากับเครื่องมือไฟฟ้าอย่างแน่นหนาและปรับตำแหน่งให้ได้ความปลอดภัยสูงสุด** ทั้งนี้เพื่อให้จานไหลเข้าหาตัวผู้ใช้เครื่องมือที่สุด กระบังช่วยปกป้องผู้ใช้เครื่องจากชิ้นส่วนจานที่แตกหัก การสัมผัสกับจานโดยไม่ตั้งใจ และประกายไฟที่อาจจุดเสื้อผ้าให้ลุกไหม้ได้
- ▶ **ต้องใช้จานสำหรับการใช้งานที่แนะนำเท่านั้น ตัวอย่างเช่น: อย่าใช้ตัวตัดด้วยด้านข้างของจานตัดออก** จานตัดออกผลิตไว้เพื่อให้ใช้ตรงขอบนอกของจานตัดวัสดุแรงด้านข้างที่กดลงบนแผ่นจานอาจทำให้จานแตกละเอียดได้
- ▶ **ใช้หน้าแปลนรองรับที่ไม่ชำรุดที่มีขนาดและรูปร่างที่ถูกต้องสำหรับจานที่ท่านเลือกเสมอ** หน้าแปลนรองรับที่ถูกต้องจะหนุนจาน และด้วยเหตุนี้จึงลดการแตกหักของจาน หน้าแปลนรองรับสำหรับจานตัดอาจมีลักษณะต่างจากหน้าแปลนรองรับสำหรับจานขัด
- ▶ **อย่าใช้จานที่สึกกร่อนมาจากเครื่องมือไฟฟ้าขนาดใหญ่กว่า** จานที่ผลิตไว้สำหรับเครื่องมือไฟฟ้าขนาดใหญ่กว่าไม่เหมาะจะนำมาใช้กับเครื่องมือไฟฟ้าขนาดเล็กกว่าที่มีความเร็วสูงกว่า และอาจแตกระเบิดได้

คำเตือนเพิ่มเติมเพื่อความปลอดภัยเฉพาะสำหรับการตัด

- ▶ **อย่าทำให้จานตัด “ติดขัด” หรือใช้แรงกดมากเกินไป** อย่าพยายามตัดลึกมากเกินไป การออกแรงกดจานลงมากเกินไป จะเพิ่มแรงกดที่จานและอาจทำให้จานบิดหรือติดขัดในร่องตัดได้ง่ายขึ้น และยังเพิ่มความเสี่ยงในการติดกลับหรือทำให้จานแตกหักได้
- ▶ **อย่าให้ร่างกายของท่านอยู่ด้านหลังหรืออยู่ในแนวเดียวกับจานตัดที่กำลังหมุน** ขณะที่จานอยู่ในชิ้นงานและมีการเคลื่อนที่ โอกาสที่เครื่องจะสะดุดอาจเกิดขึ้นได้ และจานที่กำลังหมุน รวมทั้งเครื่องมือไฟฟ้าอาจติดกลับเข้าหาร่างกายของท่านได้โดยตรง
- ▶ **เมื่อจานติดขัดหรือเมื่อการตัดถูกขัดจังหวะด้วยเหตุผลใดก็ตาม ให้ปิดสวิตช์เครื่องมือไฟฟ้าและจับเครื่องมือไฟฟ้าค้างไว้จนจานหยุดสนิท** อย่าพยายามเอาจานตัดออกจากร่องตัดในขณะที่จานกำลังเคลื่อนที่อย่างเด็ดขาด มิฉะนั้นอาจทำให้เครื่องสั่นได้ ตรวจสอบและแก้ไขเพื่อขจัดสาเหตุที่ทำให้จานติดขัด
- ▶ **อย่าเริ่มตัดในชิ้นงานอีกครั้ง** ปล่อยให้จานหมุนถึงความเร็วเต็มก่อน จากนั้นจึงเริ่มตัดอีกครั้งอย่างระมัดระวัง จานอาจติดขัด กระโดดขึ้น หรือติดกลับ หากเบ็ดเครื่องมือไฟฟ้าทำงานอีกครั้งในชิ้นงาน
- ▶ **หมุนแผ่นกระดาษหรือชิ้นงานขนาดใหญ่เพื่อลดความเสี่ยงที่จานจะถูกหนีบและติดกลับ** ชิ้นงานขนาดใหญ่มักจะห้อยหย่อนตามความถ่วงน้ำ

หนักของตัวชิ้นงานเอง ต้องสอดแผ่นหนุนใต้ชิ้นงานทั้งสองด้าน ทั้งใกล้เส้นตัดและใกล้ขอบของชิ้นงาน

- ▶ **ใช้ความระมัดระวังเป็นพิเศษเมื่อทำการ “ตัดแบบเปิดช่อง”** เข้าไปในผนังที่มีอยู่หรือบริเวณจุดบอดอื่นๆ จานที่ยื่นออกมาอาจตัดเข้าไปท่อแก๊สหรือท่อน้ำ สายไฟฟ้า หรือวัตถุที่อาจทำให้เกิดการติดกลับได้

คำเตือนเพื่อความปลอดภัยเฉพาะสำหรับการขัดด้วยกระดาษทราย

- ▶ **อย่าใช้แผ่นกระดาษทรายที่มีขนาดใหญ่เกินไป ให้ปฏิบัติตามคำแนะนำของบริษัทผู้ผลิตเมื่อเลือกกระดาษทราย** กระดาษทรายที่มีขนาดใหญ่กว่าที่ยื่นยาวออกนอกแผ่นรองขัดอาจทำให้เกิดการบาดเจ็บ และกระดาษทรายอาจถูกเหนียวรั้ง ฉีกขาด หรือทำให้เกิดการติดกลับได้

คำเตือนเพื่อความปลอดภัยเฉพาะสำหรับการขัดด้วยแปรงลวด

- ▶ **พึงคำนึงไว้ว่าแม้ขณะใช้แปรงขัดตามปกติ** ขนแปรงลวดอาจจะหลุดออกจากแปรงไปเองได้ อยากระบายลวดลงหนักเกินไปโดยใช้กำลังย่ำลงบนแปรง ขนแปรงลวดสามารถแทงทะลุผิวหนัง และ/หรือผิวหนังได้อย่างง่ายดาย
- ▶ **เมื่อต้องการขัดด้วยแปรงลวด** หากมีการแนะนำให้ใช้เครื่องป้องกันร่วมด้วย ต้องตรวจสอบไม่ให้จานลวดหรือแปรงลวดแทรกเข้าไปในตัวกระบัง จานลวดหรือแปรงลวดอาจมีขนาดเส้นผ่าศูนย์กลางกว้างขึ้นเนื่องจากแรงกดและแรงเหวี่ยงจากจุดศูนย์กลาง

คำแนะนำเพื่อความปลอดภัยเพิ่มเติม



สวมแว่นตาป้องกันอันตราย

- ▶ **ใช้เครื่องตรวจจับที่เหมาะสมเพื่อตรวจหาสายไฟฟ้าหรือท่อสาธารณูปโภคที่อาจซ่อนอยู่ในบริเวณทำงานหรือติดต่อบริษัทสาธารณูปโภคในพื้นที่เพื่อขอความช่วยเหลือ** การสัมผัสกับสายไฟฟ้าอาจทำให้เกิดไฟไหม้หรือถูกไฟฟ้าดูด การทำให้ท่อแก๊สเสียหายอาจทำให้แก๊สระเบิด การเจาะเข้าในท่อน้ำ ทำให้รั่วซึมเสียหาย
- ▶ **อย่าสัมผัสจานตัดและขัดจนกว่าจะเย็นลง** ขณะทำงานจานจะร้อนมาก
- ▶ **เมื่อแหล่งจ่ายไฟฟ้าถูกขัดจังหวะ** ต. ย. เช่น เนื่องจากถอดแบตเตอรี่ออก ให้ปลดล๊อคสวิตช์เปิด-ปิด และสับสวิตช์ไปที่ตำแหน่งปิด ในลักษณะนี้จะช่วยป้องกันไม่ให้เครื่องติดสวิตช์อีกครั้งอย่างควบคุมไม่ได้

- ▶ **ยึดชิ้นงานให้แน่น** การยึดชิ้นงานด้วยเครื่องมือหรือแท่นจับจะมั่นคงกว่าการยึดด้วยมือ
- ▶ **เมื่อแบตเตอรี่ชาร์จและนำไปใช้งานอย่างไม่ถูกต้อง อาจมีไอระเหยออกมาได้** แบตเตอรี่อาจเผาไหม้หรือระเบิดได้ให้สูดอากาศบริสุทธิ์และไปพบแพทย์ในกรณีเจ็บปวด ไอระเหยอาจทำให้ระบบหายใจระคายเคือง
- ▶ **อย่าเปิดแบตเตอรี่** อันตรายจากการลัดวงจร
- ▶ **วัตถุที่แหลมคม ต. ย. เช่น ตะปูหรือไขควง หรือแรงกระทำภายนอก อาจทำให้แบตเตอรี่เสียหายได้** สิ่งเหล่านี้อาจทำให้เกิดการลัดวงจรภายในและแบตเตอรี่ใหม่ มีควัน ระเบิด หรือร้อนเกินไป
- ▶ **ใช้แบตเตอรี่พิเศษเฉพาะในผลิตภัณฑ์ของผู้ผลิตเท่านั้น** ในลักษณะนี้ แบตเตอรี่พิเศษจะได้รับการปกป้องจากการใช้งานเกินกำลังซึ่งเป็นอันตราย



ปกป้องแบตเตอรี่จากความร้อน รวมทั้ง ต. ย. เช่น จากการถูกแสงแดดส่องต่อเนื่อง จากไฟส่องสปริง น้ำ และความชื้น อันตรายจากการระเบิดและการลัดวงจร



- ▶ **ระวัง!** การใช้เครื่องมือไฟฟ้าพร้อม Bluetooth® อาจรวมกวนอุปกรณ์และเครื่องมืออื่นๆ เครื่องบิน และอุปกรณ์ทางการแพทย์ (เช่น เครื่องกระตุ้นหัวใจ เครื่องช่วยฟัง) นอกจากนี้ยังอาจเกิดความเสียหายต่อคนและสัตว์ในบริเวณใกล้เคียงด้วย อย่าใช้เครื่องมือไฟฟ้าพร้อม Bluetooth® ใกล้อุปกรณ์ทางการแพทย์ สถานีบริการน้ำมัน โรงงานสารเคมี พื้นที่ที่มีบรรยากาศเสี่ยงต่อการระเบิด และพื้นที่ปฏิบัติการระเบิด อย่าใช้เครื่องมือไฟฟ้าพร้อม Bluetooth® ในเครื่องบิน หลีกเลี่ยงการทำงานเป็นระยะเวลานานตรงบริเวณใกล้ร่างกายโดยตรง

เครื่องหมายข้อความ Bluetooth® และยี่ห้อเป็นเครื่องหมายการค้าจดทะเบียนและเป็นกรรมสิทธิ์ของ Bluetooth SIG, Inc. บริษัท Robert Bosch Power Tools GmbH ได้รับใบอนุญาตใช้งานเครื่องหมายข้อความ/โลโก้ดังกล่าว

รายละเอียดผลิตภัณฑ์และข้อมูล

จำเพาะ



อ่านค่าเตือนเพื่อความปลอดภัยและคำแนะนำทั้งหมด การไม่ปฏิบัติตามค่าเตือนและคำสั่งอาจเป็นสาเหตุให้ถูกไฟฟ้าดูด เกิดไฟไหม้และ/หรือได้รับบาดเจ็บอย่างร้ายแรง

กรุณาดูภาพประกอบในส่วนหน้าของคู่มือการใช้งาน

ประโยชน์การใช้งานของเครื่อง

เครื่องนี้ใช้สำหรับตัด กัดฉิวหยาบ และแปรงวัสดุที่เป็นโลหะและหินโดยไม่ต้องหยุดน้ำ สำหรับการตัดด้วยอุปกรณ์ทำจากวัสดุขัดถูชนิดที่ใช้ตัวประสาน (bonded abrasives) ต้องใช้กระบ้งป้องกันอันตรายสำหรับการตัด (อุปกรณ์ประกอบ)

เมื่อตัดหิน ต้องจัดให้มีการดูดฝุ่นอย่างเพียงพอ

เครื่องมือไฟฟ้านี้สามารถใช้สำหรับขัดด้วยกระดาษทรายเมื่อใช้เครื่องมือขัดที่ได้รับอนุญาต

เมื่อมี Bluetooth® Low Energy Module GCY 42 ใส่อุปกรณ์จะสามารถถ่ายโอนข้อมูลและการตั้งค่าของเครื่องมือไฟฟ้าระหว่างเครื่องมือไฟฟ้าและอุปกรณ์เคลื่อนที่ปลายทางผ่านเทคโนโลยีไร้สาย Bluetooth®

ส่วนประกอบที่แสดงภาพ

ลำดับเลขของส่วนประกอบผลิตภัณฑ์อ้างอิงถึงส่วนประกอบของเครื่องที่แสดงในหน้าภาพประกอบ

- (1) คันปลดล็อคกระบ้งป้องกันอันตราย
- (2) ลูกศรบอกทิศทางหมุนบนครอบเครื่อง
- (3) ปุ่มล็อคแกน
- (4) User Interface
- (5) สวิตช์เปิด-ปิด
- (6) ฝาครอบ Bluetooth® Low Energy Module GCY 42
- (7) แบตเตอรี่^{A)}
- (8) แป้นปลดล็อคแบตเตอรี่^{A)}
- (9) ด้ามจับเพิ่ม (พื้นผิวจับหุ้มฉนวน)
- (10) กระบ้งป้องกันอันตรายสำหรับการขัด
- (11) น็อตรองจานพร้อมโอริง
- (12) จานขัด
- (13) น็อตยึด
- (14) หัวขัดคาร์ไบด์^{A)}
- (15) กระบ้งป้องกันอันตรายสำหรับการตัด^{A)}
- (16) จานตัด^{A)}
- (17) ด้ามจับ (พื้นผิวจับหุ้มฉนวน)
- (18) แกนเครื่อง
- (19) การ์ดป้องกันมือ^{A)}
- (20) แผ่นขัดยาง^{A)}
- (21) กระดาษทราย^{A)}
- (22) น็อตกลม^{A)}
- (23) แปรงขัดรูปถ้วย^{A)}

- (24) กระจกเพชรเจาะคอนกรีต^{A)}
 (25) ไฟแสดงสถานะการชาร์จแบตเตอรี่ (User Interface)
 (26) ไฟแสดงการปิดการไหลย้อนกลับ (User Interface)
 (27) ปุ่มสำหรับตั้งความเร็วรอบล่วงหน้า (User Interface)
 (28) ไฟแสดงระดับความเร็วรอบ/โหมด (User Interface)

- (29) ไฟแสดงสมาร์ตโฟน (User Interface)
 (30) ไฟแสดงสถานะเครื่องมือไฟฟ้า (User Interface)
 (31) ไฟแสดงอุณหภูมิ (User Interface)
 (32) แผ่นขัดทรายซ้อน^{A)}

A) อุปกรณ์ประกอบที่แสดงภาพหรืออธิบายไม่รวมอยู่ในการจัดส่งมาตรฐาน
 กรุณาดูอุปกรณ์ประกอบทั้งหมดในรายการแสดงอุปกรณ์ประกอบของเรา

ข้อมูลทางเทคนิค

เครื่องเจียรคอมมู		GWS 18V-15 C	GWS 18V-15 SC
หมายเลขสินค้า		3 601 JH6 0..	3 601 JH6 1..
แรงดันไฟฟ้าพิกัด	V=	18	18
อัตราความเร็วพิกัด ^{A)}	นาที ¹	11000	11000
ความเร็วรอบเดินเปล่า ^{B)}	นาที ¹	9800	3400–9800
เส้นผ่าศูนย์กลางจานขัด สูงสุด	มม.	100	100
เกลียวแกนเครื่อง		M 10	M 10
ความยาวเกลียวของแกนเครื่อง สูงสุด	มม.	16	16
การยับยั้งการตีกลับ		●	●
การป้องกันการรีสตาร์ท		●	●
เบรกกันการหมุนต่อ		●	●
การตั้งความเร็วรอบล่วงหน้า		-	●
น้ำหนักตามระเบียบการ EPTA-Procedure 01:2014 ^{C)}			
- มีด้ามจับเพิ่มที่ลดการสั่นสะเทือน	กก.	2,5–3,5	2,5–3,5
- มีด้ามจับเพิ่มมาตรฐาน	กก.	2,3–3,3	2,3–3,3
อุณหภูมิโดยรอบที่แนะนำเมื่อชาร์จ	°C	0 ... +35	0 ... +35
อุณหภูมิโดยรอบที่อนุญาตเมื่อใช้งาน ^{D)} และระหว่างการเก็บรักษา	°C	-20 ... +50	-20 ... +50
แบตเตอรี่ที่ใช้งานร่วมกันได้		GBA 18V... ProCORE18V...	GBA 18V... ProCORE18V...
แบตเตอรี่ที่แนะนำให้ใช้อย่างเต็มประสิทธิภาพ		ProCORE18V... ≥ 5.5 Ah	ProCORE18V... ≥ 5.5 Ah
เครื่องชาร์จที่แนะนำ		GAL 18... GAX 18... GAL 36...	GAL 18... GAX 18... GAL 36...
การถ่ายโอนข้อมูล			
Bluetooth®		Bluetooth® 4.2 (Low Energy) ^{E)}	Bluetooth® 4.2 (Low Energy) ^{E)}

เครื่องเจียร์คอมมูม		GWS 18V-15 C	GWS 18V-15 SC
ระยะห่างสัญญาณ	วินาที	8	8
ช่วงสัญญาณสูงสุด ^{F)}	ม.	30	30

- A) ความเร็วในการจัดอันดับตามมาตรฐาน EN 60745-2-3
- B) วัตต์ 20-25 °C พร้อมแบตเตอรี่ ProCORE18V 8.0Ah และขึ้นอยู่กับระดับประจุของแบตเตอรี่และอุณหภูมิการทำงานของอุปกรณ์
- C) ขึ้นอยู่กับแบตเตอรี่แพ็คที่ใช้
- D) สมรรถภาพจะน้อยลงที่อุณหภูมิ <0 °C
- E) อุปกรณ์เคลื่อนที่ปลายทางต้องเข้ากันได้กับอุปกรณ์ Bluetooth®-Low-Energy (รุ่น 4.2) และรองรับ Generic Access Profile (GAP)
- F) ช่วงสัญญาณอาจแตกต่างกันมาก ทั้งขึ้นอยู่กับเงื่อนไขภายนอก รวมทั้งอุปกรณ์รับสัญญาณที่ใช้ ภายในพื้นที่ปิดและเมื่อมีตัวกั้นที่เป็นโลหะ (เช่น ผนัง ชั้นวางของ กระเป๋าเดินทาง ฯลฯ) ช่วงสัญญาณ Bluetooth® อาจลดลงอย่างชัดเจน

การติดตั้ง

ใส่ Bluetooth® Low Energy Module GCY 42

หมายเหตุ: สำหรับเครื่องมือไฟฟ้า GWS 18V-15 C จะมี Bluetooth® Low Energy Module GCY 42 ให้ใช้ เป็นอุปกรณ์ประกอบ; สำหรับเครื่องมือไฟฟ้า GWS 18V-15 SC จะมีลูทูนี่รวมอยู่ในการจัดส่ง สำหรับข้อมูลเกี่ยวกับโมดูล Bluetooth® Low Energy Module **GCY 42** กรุณาอ่านหนังสือคู่มือการใช้งานที่เกี่ยวข้อง

การชาร์จแบตเตอรี่

- ▶ **ใช้เฉพาะเครื่องชาร์จแบตเตอรี่ที่ระบุในข้อมูลทางเทคนิคเท่านั้น** เฉพาะเครื่องชาร์จแบตเตอรี่เหล่านี้เท่านั้นที่เข้าชุดกับแบตเตอรี่ลิเธียมไอออน ที่ใช้ในเครื่องมือไฟฟ้าของท่าน

หมายเหตุ: แบตเตอรี่แพ็คที่จัดส่งมาถูกชาร์จมาแล้วบางส่วน เพื่อให้แบตเตอรี่แพ็คทำงานได้เต็มประสิทธิภาพ ต้องชาร์จแบตเตอรี่แพ็คในเครื่องชาร์จแบตเตอรี่ให้เต็มก่อนใช้งานเครื่องมือไฟฟ้าของท่านเป็นครั้งแรก

แบตเตอรี่ลิเธียม ไอออน

สามารถชาร์จได้ตลอดเวลาโดยอายุการใช้งานจะไม่ลดลง การขัดจังหวะกระบวนการชาร์จไม่ทำให้แบตเตอรี่แพ็คเสียหาย “Electronic Cell Protection (ECP)” ช่วยป้องกันไม่ให้แบตเตอรี่ลิเธียม ไอออน จ่ายกระแสไฟออกอีก เมื่อแบตเตอรี่แพ็คหมดไฟ จะจรรยาป้องกันระดับสวิทซ์เครื่องเครื่องมือที่ใส่อยู่จะไม่หมุนต่อ

- ▶ **เมื่อเครื่องมือไฟฟ้าปิดสวิทซ์ลงโดยอัตโนมัติ อย่างกะทันหัน** ปิด อีกต่อไป แบตเตอรี่แพ็คอาจชาร์จได้

ปฏิบัติตามคำแนะนำสำหรับการกำจัดที่ถูกต้อง

การถอดแบตเตอรี่

แบตเตอรี่ (7) มีการล็อกสองระดับเพื่อป้องกันไม่ให้แบตเตอรี่ร่วงหลุดออกมาหากกดแป้นปลดล็อกแบตเตอรี่ (8) โดยไม่ตั้งใจ เมื่อแบตเตอรี่ถูกบรรจุอยู่ในเครื่องมือไฟฟ้า สปริงจะยึดแบตเตอรี่ให้เข้าตำแหน่ง

เมื่อต้องการถอดแบตเตอรี่ (7) ออกให้กดแป้นปลดล็อกแบตเตอรี่ (8) และดึงแบตเตอรี่ออกจากเครื่องมือไฟฟ้า **อย่าใช้กำลังดึง**

ไฟแสดงสถานะการชาร์จแบตเตอรี่

ไฟ LED สีเขียวของการแสดงสถานะการชาร์จแบตเตอรี่ แสดงสถานะการชาร์จของแบตเตอรี่ ด้วยเหตุผลด้านความปลอดภัยท่านสามารถตรวจสอบสถานะการชาร์จเฉพาะเมื่อเครื่องมือไฟฟ้าหยุดสนิทเท่านั้น

กดปุ่มสำหรับไฟแสดงสถานะการชาร์จแบตเตอรี่ ☺ หรือ ☹ เพื่อแสดงสถานะการชาร์จ ท่านสามารถกดได้แม้เมื่อถอดแบตเตอรี่ออกแล้ว

หลังจากกดปุ่มสำหรับไฟแสดงสถานะการชาร์จแบตเตอรี่แล้ว ไฟ LED ไม่ติดขึ้น แสดงว่าแบตเตอรี่พร้อมและต้องเปลี่ยนใหม่

หมายเหตุ: สถานะการชาร์จแบตเตอรี่จะปรากฏบน User Interface (4) (ดู "ไฟแสดงสถานะ", หน้า 57) ที่อยู่ด้านบนหรือด้านข้างสั้นๆ

แบตเตอรี่-ชนิด GBA 18V...



LED	ความจุ
ส่องสว่างต่อเนื่อง 3× สีเขียว	60-100 %
ส่องสว่างต่อเนื่อง 2× สีเขียว	30-60 %

LED	ความจุ
ส่องสว่างต่อเนื่อง 1× สีเขียว	5-30 %
ไฟกะพริบ 1× สีเขียว	0-5 %

แบตเตอรี่ชนิด ProCORE18V...



LED	ความจุ
ส่องสว่างต่อเนื่อง 5× สีเขียว	80-100 %
ส่องสว่างต่อเนื่อง 4× สีเขียว	60-80 %
ส่องสว่างต่อเนื่อง 3× สีเขียว	40-60 %
ส่องสว่างต่อเนื่อง 2× สีเขียว	20-40 %
ส่องสว่างต่อเนื่อง 1× สีเขียว	5-20 %
ไฟกะพริบ 1× สีเขียว	0-5 %

การติดตั้งอุปกรณ์ป้องกันอันตราย

- ▶ ถอดแบตเตอรี่ออกจากเครื่องมือไฟฟ้าก่อนทำการปรับแต่งใดๆ ที่เครื่องมือไฟฟ้า (ต. ย. เช่น บำรุงรักษา เปลี่ยนเครื่องมือ ฯลฯ) รวมทั้งเมื่อขนย้ายและเก็บรักษาอันตรายจากการบาดเจ็บหากสวิทช์เปิด-ปิดติดขึ้นอย่างไม่ตั้งใจ

หมายเหตุ: หากงานขัดแตกหักขณะปฏิบัติงาน หรืออุปกรณ์จับยึดบนกระบังป้องกันอันตราย/เครื่องมือไฟฟ้าเกิดชำรุด ต้องส่งเครื่องไปซ่อมบำรุงที่ศูนย์บริการหลังการขายในพื้นที่สำหรับที่อยู่ "คู่มือ" การบริการหลังการขายและคำแนะนำการใช้งาน

กระบังป้องกันอันตรายสำหรับการขัด

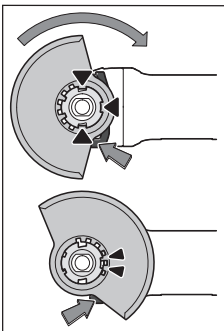

วางกระบังป้องกันอันตราย (10) บนที่จับบนเครื่องมือไฟฟ้าจนลิมล็อก ตำแหน่งของกระบังป้องกันอันตรายตรงกับที่จับ สำหรับการติดตั้งกล่าวให้กดคันปลดล็อก (1) กดกระบังป้องกันอันตราย (10) ลงบนปลดออกแกนจนขาของกระบังป้องกันอันตรายอยู่บนหน้าแปลนของเครื่องมือไฟฟ้าและหมุนกระ

บังป้องกันอันตรายไปจนได้ยินเสียงคลิกเข้าที่ ปรับตำแหน่งกระบังป้องกันอันตราย (10) ให้เข้ากับการ

ทำงาน สำหรับการติดตั้งกล่าวให้กดคันปลดล็อก (1) ขึ้นและหมุนกระบังป้องกันอันตราย (10) ไปยังตำแหน่งที่ต้องการ

- ▶ **จัดวางตำแหน่งกระบังป้องกันอันตราย (10) ในลักษณะให้ลิมทั้งคู่ของคันปลดล็อก (1) เกียวในช่องเปิดที่สอดคล้องกันของกระบังป้องกันอันตราย (10) เสมอ**
- ▶ **ปรับกระบังป้องกันอันตราย (10) ในลักษณะป้องกันไม่ให้ประกายไฟแลมเข้าหาตัวผู้ใช้เครื่อง**
- ▶ **กระบังป้องกันอันตราย (10) จะต้องหมุนปรับได้โดยการกดปุ่มปลดล็อก (1) เท่านั้น! มิฉะนั้นจะต้องไม่ใช้เครื่องมือไฟฟ้าอีกต่อไปในทุกกรณีและต้องส่งเครื่องไปยังศูนย์บริการหลังการขาย**

หมายเหตุ: ลิมล็อกตำแหน่งบนกระบังป้องกันอันตราย (10) ทำให้มั่นใจว่าเฉพาะกระบังป้องกันอันตรายที่เหมาะสมเท่านั้นจะสามารถติดตั้งเข้ากับเครื่องมือไฟฟ้าได้

กระบังป้องกันอันตรายสำหรับการตัด

- ▶ **สำหรับการตัดด้วยอุปกรณ์ทำจากวัสดุขัดถูชนิดที่ใช้ตัวประสาน (bonded abrasives) ต้องใช้กระบังป้องกันอันตรายสำหรับการตัด (15) เสมอ**
- ▶ **ต้องจัดเตรียมให้มีการผูกคูลูกดอกอย่างพอเพียงเมื่อตัดหิน**

ติดตั้งกระบังป้องกันอันตรายสำหรับการตัด (15) เข้าในลักษณะเดียวกับกระบังป้องกันอันตรายสำหรับการขัด (10)

ด้ามจับเพิ่ม

- ▶ **ใช้เครื่องมือไฟฟ้าพร้อมกับด้ามจับเพิ่ม (9) เสมอ**
- ▶ **ขันด้ามจับเพิ่ม (9) เข้าบนด้านซ้ายหรือด้านขวาของหัวเครื่องตามลักษณะงาน**

ด้ามจับเพิ่มลดการสั่นสะเทือน



ด้ามจับเพิ่มลดการสั่นสะเทือนช่วยลดแรงสั่นสะเทือนให้เบา

างลงและทำให้ปฏิบัติงานได้สะดวกและปลอดภัยยิ่งขึ้น

- ▶ **อย่าทำการตัดแปลงใดๆ ที่ด้ามจับเพิ่ม**
- ▶ **อย่าใช้ด้ามจับเพิ่มที่ชำรุดหักงอ**

การ์ดป้องกันมือ

- ▶ **เมื่อใช้แผ่นขัดยาง (20) หรือแปรงขัดรูปถ้วย/แปรงแผ่น/แผ่นขัดทรายซ้อนต้องประกอบการ์ดป้องกันมือ (19) เข้าเสมอ**

ยึดการ์ดป้องกันมือ (19) เข้ากับด้ามจับเพิ่ม (9)

การติดตั้งเครื่องมือขัด

- ▶ **ถอดแบตเตอรี่ออกจากเครื่องมือไฟฟ้าก่อนทำการปรับแต่งใดๆ ที่เครื่องมือไฟฟ้า (ต. ย. เช่น บำรุงรักษา**

เปลี่ยนเครื่องมือ ฯลฯ) รวมทั้งเมื่อขนย้ายและเก็บรักษา
อันตรายจากการบาดเจ็บหากสวิทช์เปิด-ปิดติดขึ้นอย่างไม่
ตั้งใจ

- ▶ **อย่าสัมผัสจานตัดและขัดจนกว่าจะเย็นลง** ขณะทำงาน
จานจะร้อนมาก

ทำความสะอาดแกนขัด (18) และทุกชิ้นส่วนที่จะติดตั้ง
เมื่อต้องการหนีบและคลายเครื่องมือขัด ให้กดปุ่มล็อคแกน
(3) เพื่อล๊อคแกนขัด

- ▶ **กดปุ่มล็อคแกนเมื่อแกนหยุดสนิทแล้วเท่านั้น** มิฉะนั้น
เครื่องอาจชำรุดได้

จานตัด/ขัด

สังเกตขนาดของเครื่องมือขัด เส้นผ่าศูนย์กลางของรูยึดต้องมี
ขนาดพอดีกับนอตตรงจาน อย่าวใส่ขอลดหรือข้อปรับขนาด
เมื่อใส่จานตัดเพชร ให้ตรวจสอบให้ทิศทางหมุนของลูกศรบน
จานตัดเพชรตรงกับทิศทางหมุนของเครื่องมือไฟฟ้า (ดูลูกศร
ทิศทางหมุนบนหัวเครื่อง)

สำหรับลำดับการติดตั้ง ดูหน้าภาพประกอบ

สำหรับการติดตั้งจานตัด/ขัดให้ขันนอตยึด (13) และยึดให้
แน่นด้วยประแจสองรู

- ▶ **เมื่อติดตั้งเครื่องมือขัดแล้ว ก่อนเปิดสวิทช์ทำงาน ให้**
ตรวจสอบว่าได้ติดตั้งเครื่องมือขัดอย่างถูกต้องและ
เครื่องมือขัดสามารถหมุนได้อย่างอิสระหรือไม่ ตรวจสอบ
ให้แน่ใจว่าเครื่องมือขัดไม่ครูดกับกระบังป้องกัน
อันตรายหรือส่วนอื่นๆ

แผ่นขัดทรายซ้อน

- ▶ **เมื่อทำงานด้วยแผ่นขัดทรายซ้อนให้ประกอบการ์ด**
ป้องกันมือ (19) เข้าเสมอ

แผ่นขัดยาง

- ▶ **เมื่อทำงานกับแผ่นขัดยาง (20) ให้ติดตั้งการ์ด**
ป้องกันมือ (19) เสมอ

สำหรับลำดับการติดตั้ง ดูหน้าภาพประกอบ

เลื่อนแผ่นขัดยาง (20) ไปบนแกนเครื่อง (18)

กดกระดาะทราย (21) ลงบนด้านล่างของแผ่นขัดยาง (20)
อย่างแน่นหนา

ขันนอตกลม (22) และยึดให้แน่นด้วยประแจสองรู

แปรงรูปถ้วย/แปรงแผ่น

- ▶ **เมื่อทำงานกับแปรงรูปถ้วย/แปรงแผ่น ให้ติดตั้งการ์ด**
ป้องกันมือ (19) เสมอ

สำหรับลำดับการติดตั้ง ดูหน้าภาพประกอบ

ต้องสามารถขันแปรงรูปถ้วย/แปรงแผ่นเข้าบนแกนขัดจนทาบ
สนิทกับหน้าแปลนแกนขัดที่ปลายเกลียวของแกนขัด ยึดแปรง
รูปถ้วย/แปรงแผ่นให้แน่นด้วยประแจปากตาย

หัวขัดคาร์ไบด์



- ▶ **ให้ใช้หัวขัดเฉพาะกับกระบังป้องกันอันตรายที่เหมาะสม**
เท่านั้น

เครื่องมือขัดที่ได้รับอนุญาต

ท่านสามารถใช้งานเครื่องมือขัดทั้งหมดที่ระบุในคู่มือการใช้งาน
งานเล่มนี้

ความเร็วรอบหมุน [นาที⁻¹] หรือความเร็วตามเส้นรอบวง
[เมตร/วินาที] ที่อนุญาตของเครื่องมือขัดที่ใช้อย่างน้อยจะ
ต้องเท่ากับค่าที่กำหนดไว้ในตารางด้านล่างนี้

ดังนั้นให้สังเกตความเร็วรอบหมุนหรือความเร็วตามเส้น
รอบวงที่อนุญาตบนฉลากของเครื่องมือขัด

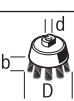
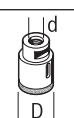
	สูงสุด [มม.]	[มม.]			
	D	b	d	[นาที ⁻¹]	[ม./วินาที]
	100	7	16	11000	80
	100	-	-	11000	80
	75	30	M 14	11000	45
	82	-	M 14	11000	80

การหมุนหัวเครื่อง (GWS 18V-15 C)

- ▶ **ถอดแบตเตอรี่ออกจากเครื่องมือไฟฟ้าก่อนทำการปรับ**
แต่งใดๆ ที่เครื่องมือไฟฟ้า (ต. ย. เช่น บำรุงรักษา
เปลี่ยนเครื่องมือ ฯลฯ) รวมทั้งเมื่อขนย้ายและเก็บรักษา
อันตรายจากการบาดเจ็บหากสวิทช์เปิด-ปิดติดขึ้นอย่างไม่
ตั้งใจ

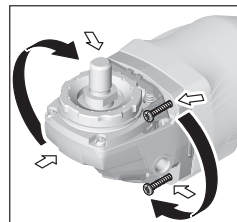

ท่านสามารถหมุนหัวเครื่อง
ได้เป็นขั้นทุกๆ 90° ใน
ลักษณะนี้ท่านสามารถนำสวิตช์
เปิด-ปิดไปยังตำแหน่งที่
สะดวกต่อการใช้งานยิ่งขึ้น
สำหรับสภาพการทำงาน
พิเศษ ต. ย. เช่น สำหรับผู้
ถนัดมือซ้าย

ชั้นสกรู 4 ตัวออกจนสุด หมุนหัวเครื่องไปยังตำแหน่งใหม่
อย่างระมัดระวังโดยไม่ถอดออกจกตัวเรือน ชั้นสกรู 4 ตัว
กลับเข้าที่แน่น

การถอดฝุ่น/ขี้เลื่อย

ฝุ่นที่ได้จากวัสดุ เช่น เคลือบผิวที่มีสารตะกั่ว ไม้ยางประเภท
แรชวูด และโลหะ อาจเป็นอันตรายต่อสุขภาพ การ
สัมผัสหรือการหายใจเอาฝุ่นเข้าไปอาจทำให้เกิดปฏิกิริยาแพ้
ฝุ่น และ/หรือนำมาซึ่งโรคติดเชื้อระบบหายใจแก่ผู้
ใช้เครื่องหรือผู้ที่ยืนอยู่ใกล้เคียง

ฝุ่นบางประเภท เช่น ฝุ่นไม้โอ๊ก หรือไม้บีช นับ
เป็นสารที่ทำให้เกิดมะเร็ง โดยเฉพาะอย่างยิ่งเมื่อผสม
กับสารเติมแต่งเพื่อบำบัดไม้ (โครเมต ผลิตภัณฑ์รักษาเนื้อไม้)
สำหรับวัสดุที่มีแอลเบสทอสตองให้ผู้เชี่ยวชาญทำงานเท่านั้น

- จัดสถานที่ทำงานให้มีการระบายอากาศที่ดี
- ขอแนะนำให้สวมหน้ากากป้องกันการติดเชื้อที่มีระดับ-ใส่
กรอง P2

ปฏิบัติตามกฎข้อบังคับสำคัญอื่นๆ ที่เกี่ยวกับวัสดุชิ้นงาน
ที่บังคับใช้ในประเทศของท่าน

- ▶ **ป้องกันการสะสมของฝุ่นในสถานที่ทำงาน**
ฝุ่นสามารถถูกใหม่อย่างง่ายดาย

การปฏิบัติงาน

การเริ่มต้นปฏิบัติงาน

การใส่แบตเตอรี่

ต้นแบตเตอรี่ที่ชาร์จแล้ว (7) เข้าในฐานของเครื่องมือไฟฟ้า
จากทางด้านหน้าจนแบตเตอรี่ถูกล็อกอย่างแน่นหนา

การเปิด-ปิดเครื่อง

เมื่อต้องการให้เครื่องมือไฟฟ้าเริ่มต้นทำงาน ให้ดันสวิตช์
เปิด-ปิด (5) ไปข้างหน้า

เมื่อต้องการล็อคสวิตช์เปิด-ปิด (5) ให้กดสวิตช์เปิด-ปิด (5)
ลงตรงส่วนหน้าจนเข้าล็อก

การตั้งค่าความเร็วรอบล่วงหน้า (GWS 18V-15 SC)

ในค่าที่ตั้งจากโรงงานจะมีการตั้งค่าความเร็วรอบเบื้องต้นไว้ 3 ระดับ การใช้แอปพลิเคชันพิเศษ (Bosch Toolbox App) จะ
ช่วยให้สามารถตั้งค่าโปรแกรมความเร็วรอบได้ 6 ระดับ

หากมีการเปลี่ยนจำนวนระดับความเร็วรอบ ค่าของแต่ละระดับจะมีการปรับเป็นค่าเบื้องต้น ในกรณีนี้ ไฟแสดงระดับความเร็ว
รอบ/โหมด (28) จะกะพริบเป็นสีขาว หากมีการตั้งโปรแกรมค่าความเร็วรอบแบบเดียวๆ ไฟแสดงระดับความเร็วรอบ/โหมด
(28) ของระดับความเร็วรอบสามารถทำได้เป็นขั้น ขั้นละ 200 นาที¹ ในขณะเดียวกัน คอยดูให้แต่ละระดับมีตรรกะการเพิ่มขึ้น
($2 \geq 1 / 3 \geq 2$ เป็นต้น)

เมื่อต้องการปิดสวิตช์เครื่องมือไฟฟ้า ให้ปล่อยนิ้วจากสวิตช์
เปิด-ปิด (5) หรือในกรณีที่มีสวิตช์ถูกล็อกอยู่ ให้กดตรงส่วน
ท้ายของสวิตช์เปิด-ปิด (5) ลงสั้นๆ และปล่อยนิ้ว

- ▶ **ตรวจสอบเครื่องมือชั้ก่อนใช้งาน เครื่องมือชั้ต้อง
ได้รับการติดตั้งอย่างถูกต้องและสามารถหมุนได้อย่าง
อิสระ ทำการทดสอบวิ่งโดยเปิดเครื่องเดินตัวเปล่านาน
อย่างน้อย 1 นาที อย่าให้เครื่องมือชั้ที่ชำรุด เสียศูนย์
หรือสั้นตัว เครื่องมือชั้ที่ชำรุดอาจจะเปิดและทำให้เกิด
การบาดเจ็บได้**

การยับยั้งการติ๊กกลับ



หากมีการติ๊กกลับอย่างฉับพลันในเครื่องมือไฟฟ้า
ต. ย. เช่น การติดขัดในการตัดแยก การจ่าย
ไฟฟ้าไปยังมอเตอร์จะถูกขัดจังหวะด้วยระบบ
อิเล็กทรอนิกส์ ในขณะที่เดียวกัน ไฟแสดงการปิด

การไหลย้อนกลับ (26) จะส่องสว่าง เมื่อการปิดการไหลย้อน
กลับทำงาน ไฟแสดงสถานะ (30) จะกะพริบเป็นสีแดง
เมื่อต้องการ **เริ่มต้นทำงานอีกครั้ง** ให้กลับสวิตช์เปิด/ปิด (5)
ไปยังตำแหน่งปิด และเปิดสวิตช์เครื่องมือไฟฟ้าอีกครั้ง

การป้องกันการรีสตาร์ท

ระบบป้องกันการรีสตาร์ทช่วยป้องกันไม่ให้เครื่องมือไฟฟ้าเริ่ม
ต้นใหม่อีกอย่างควบคุมไม่ได้หลังจากการจ่ายไฟฟ้าถูกขัดจังหวะ
เมื่อเปิดใช้งานการป้องกันการรีสตาร์ท ไฟแสดงสถานะ (30)
จะกะพริบเป็นสีแดง

เมื่อต้องการ **เริ่มต้นทำงานอีกครั้ง** ให้กลับสวิตช์เปิด/ปิด (5)
ไปยังตำแหน่งปิด และเปิดสวิตช์เครื่องมือไฟฟ้าอีกครั้ง

การปิดสวิตช์เมื่อถูกกระแทก

ระบบปิดสวิตช์เมื่อถูกกระแทกเปิดเสร็จจะปิดสวิตช์เครื่องมือ
ไฟฟ้าทันทีที่เครื่องตกกระแทกกับพื้น ในขณะที่เดียวกัน ไฟ
แสดงสถานะ (30) จะกะพริบเป็นสีแดง

เมื่อต้องการ **เริ่มต้นทำงานอีกครั้ง** ให้กลับสวิตช์เปิด/ปิด (5)
ไปยังตำแหน่งปิด และเปิดสวิตช์เครื่องมือไฟฟ้าอีกครั้ง

User Interface (ดูภาพประกอบ A)

User Interface (4) ใช้สำหรับตั้งค่าความเร็วรอบล่วงหน้า
และแสดงสถานะของเครื่องมือไฟฟ้า

ตารางต่อไปนี้แสดงความเร็วรอบที่มีการตั้งค่าไว้เบื้องต้น (การตั้งค่าพื้นฐาน) สำหรับจำนวนระดับที่มีการตั้งโปรแกรมไว้แต่ละจำนวน

GWS 18V-15 SC	การตั้งค่าพื้นฐานความเร็วรอบเป็นระดับ					
	1	2	3	4	5	6
	[นาที ⁻¹]	[นาที ⁻¹]	[นาที ⁻¹]	[นาที ⁻¹]	[นาที ⁻¹]	[นาที ⁻¹]
จำนวนระดับความเร็วรอบ						
1	3400	-	-	-	-	-
2	3400	9800	-	-	-	-
3	3400	6600	9800	-	-	-
4	3400	5600	7600	9800	-	-
5	3400	5000	6600	8200	9800	-
6	3400	4600	6000	7200	8600	9800

ค่าที่ระบุของระดับความเร็วขึ้นอยู่กับแบตเตอรี่ที่ใช้ ระดับประจุแบตเตอรี่ และอุณหภูมิทำงานของอุปกรณ์

ท่านสามารถไขปุ่มสำหรับตั้งความเร็วรอบล่วงหน้า (27) เพื่อตั้งความเร็วรอบที่ต้องการไว้ล่วงหน้าได้แม้ในระหว่างการใช้งาน ข้อมูลในตารางต่อไปนี้เป็นคำแนะนำสำหรับการตั้งจากโรงงานที่มีระดับความเร็วรอบที่ตั้งค่าเบื้องต้นไว้ 3 ระดับ

วัสดุ	การใช้งาน	เครื่องมือ	ชั้นความเร็วรอบล่วงหน้า	GWS 18V-15 SC [นาที ⁻¹]
โลหะ	แปรง ชัดสนิมออก	แปรงขัดรูปถ้วย	1	3400
สแตนเลส	การขัด	แผ่นไฟเบอร์	2	6600
โลหะ	การขัดหยาบ	จานขัด	3	สูงสุด
โลหะ	การตัด	จานขัด	3	สูงสุด
หิน	การตัด	จานตัดเพชรและแผ่นน้ำ การตัด (อนุญาตให้ตัดหินได้เฉพาะเมื่อใช้แผ่นน้ำ การตัดเท่านั้น)	3	สูงสุด

► ความเร็ว

รอบกำหนดของอุปกรณ์ประกอบด้วยค่าความเร็วรอบสูงสุดที่ระบุไว้บนเครื่องมือไฟฟ้าเป็นอย่างน้อย

อุปกรณ์ประกอบที่หมุนเร็วกว่าความเร็วรอบกำหนดของตัว เองอาจแตกและกระเด็นออกเป็นชิ้นๆ

ไฟแสดงสถานะ

ไฟแสดงสถานะการชาร์จ	ความหมาย/สาเหตุ	วิธีแก้ปัญหา
แบตเตอรี่ (User Interface) (25)		
เขียว	ชาร์จแบตเตอรี่แล้ว	-
เหลือง	แบตเตอรี่ใกล้หมด	เปลี่ยนหรือชาร์จแบตเตอรี่ในไม่ช้า
แดง	แบตเตอรี่หมดประจุ	เปลี่ยนหรือชาร์จแบตเตอรี่

ไฟแสดงอุณหภูมิ (31)	ความหมาย/สาเหตุ	วิธีแก้ปัญหา
เหลือง	อุณหภูมิถึงขั้นวิกฤติ (มอเตอร์ อิเล็กทรอนิกส์ แบตเตอรี่)	ให้เครื่องมือไฟฟ้าวิ่งตัวเปล่าและปล่อยให้เย็นลง

ไฟแสดงอุณหภูมิ (31)	ความหมาย/สาเหตุ	วิธีแก้ปัญหา
แดง	เครื่องมือไฟฟ้าร้อนเกินไปและดับลง	ปล่อยให้เครื่องมือไฟฟ้าเย็นลง

ไฟแสดงสถานะเครื่องมือไฟฟ้า (30)	ความหมาย/สาเหตุ	วิธีแก้ปัญหา
เขียว	สถานะ OK	–
เหลือง	อุณหภูมิถึงขั้นวิกฤติหรือแบตเตอรี่ใกล้หมด	ให้เครื่องมือไฟฟ้าวิ่งตัวเปล่าและปล่อยให้เย็นลง หรือเปลี่ยนหรือชาร์จแบตเตอรี่ใหม่ซ้ำ
ส่องสว่างสีแดง	เครื่องมือไฟฟ้าร้อนเกินไปหรือแบตเตอรี่หมดประจุ	ปล่อยให้เครื่องมือไฟฟ้าเย็นลง หรือเปลี่ยนหรือชาร์จแบตเตอรี่
กะพริบสีแดง	การยับยั้งการตีกลับ การป้องกันการรีสตาร์ท หรือการปิดสวิตช์เมื่อถูกกระแทกถูกเรียกใช้ งาน	ปิดสวิตช์เครื่องมือไฟฟ้าและเปิดสวิตช์อีกครั้ง
กะพริบสีฟ้า	เครื่องมือไฟฟ้าเชื่อมต่อกับอุปกรณ์เคลื่อนที่ ปลายทางหรือกำลังถ่ายโอนการตั้งค่า	–

ฟังก์ชันการเชื่อมต่อ

เมื่อใช้ร่วมกับ *Bluetooth® Low Energy Module GCY 42* จะมีฟังก์ชันการเชื่อมต่อต่อไปนี้สำหรับเครื่องมือไฟฟ้า:

- การลงทะเบียนและตั้งค่าส่วนบุคคล
- การตรวจสอบสถานะและการส่งออกข้อความแจ้งเตือน
- ข้อมูลทั่วไปและการตั้งค่า
- การจัดการ

สำหรับข้อมูลเพิ่มเติมเกี่ยวกับโมดูล *Bluetooth® Low Energy Module GCY 42* กรุณาอ่านหนังสือคู่มือการใช้งานที่เกี่ยวข้อง

การเชื่อมต่อของเครื่องมือไฟฟ้ากับแอปจะต้องได้รับการยืนยันด้วยการกดปุ่มสำหรับตั้งความเร็วรอบล่วงหน้า (27) ที่ User Interface (4) โดยจะเป็นค่าของจากแอปขณะที่ทำการเชื่อมต่อ

ข้อแนะนำในการทำงาน

- ▶ เครื่องมือไฟฟ้าที่มี *Bluetooth® Low Energy Module GCY 42* ใส่อยู่จะมีส่วนต่อประสานทางคลื่นวิทยุ ต้องปฏิบัติตามข้อจำกัดในการใช้งานในท้องถิ่น ต. ย. เช่น ในเครื่องบิน หรือโรงพยาบาล
- ▶ ในพื้นที่ที่ไม่อนุญาตให้ใช้เทคโนโลยีไร้สาย *Bluetooth®* จะต้องถอด *Bluetooth® Low Energy Module GCY 42* และถ่านกระดุมออก
- ▶ ใช้ความระมัดระวังเมื่อเจาะช่องในผนังที่รับน้ำหนัก ดูบท "ข้อมูลเกี่ยวกับโครงสร้าง"

- ▶ ยึดชิ้นงานให้แน่น หากชิ้นงานไม่อยู่นิ่งได้ด้วยน้ำหนักของตัวเอง
- ▶ อย่าใช้งานเครื่องมือไฟฟ้าหนักเกินไปจนเครื่องหยุดชะงัก
- ▶ หลังใช้งานเครื่องมือไฟฟ้าอย่างหนัก ต้องปล่อยให้เครื่องมือไฟฟ้าตัวเปล่าต่อเป็นเวลาสองสามนาทีเพื่อให้เครื่องมือเย็นลง
- ▶ อย่าใช้เครื่องมือไฟฟ้าร่วมกับแท่นตัดออก
- ▶ อย่าสัมผัสจานตัดและขัดจนกว่าจะเย็นลง ขณะทำงานจานจะร้อนมาก

หากเครื่องมือไฟฟ้ามีประจุไฟฟ้าสถิต ระบบอิเล็กทรอนิกส์เบ็ดเสร็จจะปิดสวิตช์เครื่องมือไฟฟ้า กดสวิตช์เปิด-ปิด (5) อีกครั้งเพื่อให้เครื่องมือไฟฟ้าเริ่มทำงานใหม่

การกีดผิวหยาบ

- ▶ **อย่าใช้จานตัดสำหรับกีดผิวหยาบอย่างเด็ดขาด** ท่านจะได้ผลลัพธ์การกีดผิวหยาบที่ดีที่สุดเมื่อตั้งเครื่องที่มุม 30° และ 40° เคลื่อนเครื่องมือไฟฟ้าไปมาด้วยแรงกดปานกลาง ในลักษณะนี้ชิ้นงานจะไม่ร้อนเกินไป ไม่เปลี่ยนสี และไม่เปลี่ยน

แผ่นขัดทรายซ้อน

ท่านสามารถขัดผิวหน้าชิ้นงานที่มีรูปโค้งนูนและเส้นขอบรอบนอกได้ด้วยแผ่นขัดทรายซ้อน (อุปกรณ์ประกอบ) แผ่นขัดทรายซ้อนมีอายุการใช้งานนานกว่ามาก มีระดับเสียงรบกวนต่ำกว่า และมีอุณหภูมิการขัดต่ำกว่าจานขัดทั่วไป

การตัดโลหะ

- ▶ **สำหรับการตัดด้วยอุปกรณ์จากวัสดุคดุนชนิดที่ใช้ตัวประสาน (bonded abrasives) ต้องใช้กระบ้งป้องกันอันตรายสำหรับการตัด (15) เสมอ**

เมื่อทำงานตัด ให้เคลื่อนเครื่องไปข้างหน้าด้วยความเร็วพอประมาณที่เหมาะสมกับวัสดุชิ้นงานที่จะตัด อย่าออกแรงกดลงบนจานตัด อย่าตะแคง หรือแกว่งไปมา

อย่าหยุดจานตัดที่วิ่งด้วยแรงเฉื่อยโดยกดลงด้านข้าง

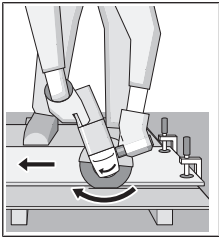

เล็กที่สุด

ต้องเคลื่อนเครื่องมือไฟฟ้าแบบบังคับเสมอ มิฉะนั้นจะเกิดอันตรายจากการที่เครื่องถูกผล็อกจากการงัดตัวอย่างควบคุมไม่ได้

เมื่อต้องการตัดเส้นรอบนอกและทอสีเหลี่ยม ขอแนะนำให้เริ่มตรงจุดที่มีหน้าตัดที่

การตัดหิน

- ▶ **ต้องจัดเตรียมให้มีการดูดฝุ่นออกอย่างพอเพียงเมื่อตัดหิน**
- ▶ **สวมหน้ากากป้องกันฝุ่น**
- ▶ **ต้องใช้เครื่องมือไฟฟ้านี้สำหรับการขัดและตัดเท่านั้น**

สำหรับการตัดหิน ทางที่ดีควรใช้จานตัดเพชร

เมื่อตัดวัสดุที่แข็งเป็นพิเศษ ต.ย. เช่น คอนกรีตที่มีกรวดผสมอยู่มาก จานตัดเพชรจะร้อนเกินไป และด้วยเหตุนี้ จะชำรุดได้ ซึ่งจะสังเกตเห็นได้ชัดจากวงประกายไฟที่หมุนไปพร้อมๆ กับจานตัดเพชร

ในกรณีนี้ให้หยุดการตัด และทำให้จานตัดเพชรเย็นลงโดยปล่อยให้เครื่องเดินตัวเปล่าที่ความเร็วรอบสูงสุดสักครู่หนึ่ง การทำงานได้น้อยลงอย่างเห็นได้ชัดและวงประกายไฟหมุนเป็นสัญญาณว่าจานตัดเพชรกำลังจะท้อ การตัดวัสดุกัดกร่อน (ต.ย. เช่น อิฐจากทรายผสมปูนขาว) เพียงเล็กน้อย จะทำให้จานกลับคมอีกครั้ง

ข้อมูลเกี่ยวกับโครงสร้าง

ช่องในผนังที่รับน้ำหนักอยู่ภายใต้มาตรฐาน DIN 1053 ตอน 1 หรือข้อบังคับเฉพาะประเทศ ต้องปฏิบัติตามกฎระเบียบนี้ในทุกกรณี ก่อนเริ่มงานให้ปรึกษานักวิศวกรโครงสร้าง สถาปนิก หรือหัวหน้าก่อสร้างที่รับผิดชอบ

คำแนะนำสำหรับการจัดการกับแบตเตอรี่อย่างเหมาะสม

ปกป้องแบตเตอรี่จากความชื้นและน้ำ

เก็บรักษาแบตเตอรี่ในช่วงอุณหภูมิ - 20 °C ถึง 50 °C เท่านั้น อย่าปล่อยให้วางแบตเตอรี่ไว้ในรถยนต์ในช่วงฤดูร้อน

ทำความสะอาดช่องระบายอากาศเป็นครั้งคราวโดยใช้แปรงขนอ่อนที่แห้งและสะอาด

หลังจากชาร์จแบตเตอรี่แล้ว

หากแบตเตอรี่มีช่วงเวลาทำงานสั้นมาก แสดงว่าแบตเตอรี่เสื่อมและต้องเปลี่ยนใหม่

ปฏิบัติตามคำแนะนำสำหรับการกำจัดที่ถูกต้อง

การบำรุงรักษาและการบริการ

การบำรุงรักษาและการทำความสะอาด

- ▶ **ถอดแบตเตอรี่ออกจากเครื่องมือไฟฟ้าก่อนทำการปรับแต่งใดๆ ที่เครื่องมือไฟฟ้า (ต.ย. เช่น บำรุงรักษา เปลี่ยนเครื่องมือ ฯลฯ) รวมทั้งเมื่อขนย้ายและเก็บรักษาอันตรายจากการบาดเจ็บหากสวิตช์เปิด-ปิดติดขึ้นอย่างไม่ตั้งใจ**
- ▶ **เพื่อให้ทำงานได้อย่างถูกต้องและปลอดภัย ต้องรักษาเครื่องและช่องระบายอากาศให้สะอาดอยู่เสมอ**

กรุณาเก็บรักษาและจับถืออุปกรณ์ประกอบอย่างระมัดระวัง

การบริการหลังการขายและการให้คำปรึกษาการใช้งาน

ศูนย์บริการหลังการขายของเรายินดีตอบคำถามของท่านที่เกี่ยวกับการบำรุงรักษาและการซ่อมแซมผลิตภัณฑ์รวมทั้งเรื่องอะไหล่ ภาพเขียนแบบการประกอบและข้อมูลเกี่ยวกับอะไหล่ กรุณาดูใน: www.bosch-pt.com

ทีมงานที่ปรึกษาของ บอช ยินดีให้ข้อมูลเกี่ยวกับผลิตภัณฑ์ของเราและอุปกรณ์ประกอบต่างๆ

เมื่อต้องการสอบถามและสั่งซื้ออะไหล่ กรุณาแจ้งหมายเลขสินค้า 10 หลักบนแผ่นป้ายรุ่นของผลิตภัณฑ์ทุกครั้ง

ไทย

ไทย บริษัท โรเบิร์ต บอช จำกัด

เอฟวายไอ เซ็นเตอร์ อาคาร 1 ชั้น 5

เลขที่ 2525 ถนนพระราม 4

แขวงคลองเตย เขตคลองเตย กรุงเทพฯ 10110

โทร: +66 2012 8888

แฟกซ์: +66 2064 5800

www.bosch.co.th

ศูนย์บริการซ่อมและฝึกอบรม บอช

อาคาร ลานชาลาทาวเวอร์ ชั้น G ห้องเลขที่ 2

บ้านเลขที่ 10/11 หมู่ 16

ถนนศรีนครินทร์ ตำบลบางแก้ว อำเภอบางพลี

จังหวัดสมุทรปราการ 10540

ประเทศไทย

โทรศัพท์ 02 7587555

โทรสาร 02 7587525

สามารถดูที่อยู่ศูนย์บริการอื่นๆ ได้ที่:

www.bosch-pt.com/serviceaddresses

การขนส่ง

แบตเตอรี่ลิเธียม ไอออน ที่บรรจุอยู่ภายใน
ได้ข้อกำหนดแห่งกฎหมายสินค้าอันตราย ผู้
ใช้สามารถขนส่งแบตเตอรี่แพ็คโดย
ทางถนนโดยไม่มีข้อบังคับอื่นทางขนส่งโดยบุคคลที่สาม
(เช่น : การขนส่งทางอากาศ หรือตัวแทนขนส่งสินค้า)
ต้องปฏิบัติตามข้อกำหนดพิเศษเกี่ยวกับการบรรจุ
ภัณฑ์และการติดฉลาก สำหรับการเตรียมสิ่งของที่จัดส่ง
จำเป็นต้องปรึกษาผู้เชี่ยวชาญด้านวัตถุอันตราย
ส่งแบตเตอรี่แพ็คเมื่อตัวหุ้มไม่ชำรุดเสียหายเท่านั้น ใช้แถบ
กาวพันปิดหน้าสัมผัสที่เปิดอยู่ และนำแบตเตอรี่แพ็ค
ใส่กล่องบรรจุโดยไม่ให้เคลื่อนไปมาในกล่องได้ นอกจากนี้
นี้กรุณาปฏิบัติตามกฎระเบียบของประเทศซึ่งอาจมีรายละเอียดเพิ่มเติม

การกำจัดขยะ



เครื่องมือไฟฟ้า แบตเตอรี่แพ็ค อุปกรณ์ประกอบ
และที่บ่อ ต้องนำ

ไปแยกประเภทวัสดุเพื่อนำกลับมาใช้
ใหม่โดยไม่ทำลายสภาพแวดล้อม



อย่าทิ้งเครื่องมือไฟฟ้าและแบตเตอรี่แพ็ค/
แบตเตอรี่ที่นำกลับมารีไซเคิลไม่ได้ ลงในขยะ
บ้าน!

แบตเตอรี่แพ็ค/แบตเตอรี่:

ลิเธียม ไอออน:

กรุณาปฏิบัติตามคำแนะนำในบทการขนส่ง (ดู "การขนส่ง",
หน้า 60)

Bahasa Indonesia

Petunjuk Keselamatan

Petunjuk Keselamatan Umum Perangkat Listrik

⚠ PERINGATAN Bacalah semua petunjuk
keselamatan dan semua petunjuk
penggunaan. Kesalahan dalam menjalankan petunjuk
keselamatan dan petunjuk penggunaan dapat
mengakibatkan sengatan listrik, kebakaran, dan/atau cedera
serius.

Simpanlah semua petunjuk keselamatan dan petunjuk penggunaan untuk acuan di masa mendatang.

Istilah "perkakas listrik" dalam petunjuk keselamatan
mengacu pada perangkat listrik yang dioperasikan dengan
listrik (menggunakan kabel) atau perangkat listrik yang
dioperasikan dengan baterai (tanpa kabel).

Keamanan tempat kerja

- ▶ **Jaga kebersihan dan pencahayaan area kerja.** Area yang berantakan atau gelap dapat memicu kecelakaan.
- ▶ **Jangan mengoperasikan perangkat listrik di lingkungan yang dapat memicu ledakan, seperti adanya cairan, gas, atau debu yang mudah terbakar.** Perangkat listrik dapat memancarkan bunga api yang kemudian mengakibatkan debu atau uap terbakar.
- ▶ **Jauhkan dari jangkauan anak-anak dan pengamat saat mengoperasikan perangkat listrik.** Gangguan dapat menyebabkan hilangnya kendali.

Keamanan listrik

- ▶ **Steker perkas listrik harus sesuai dengan stopkontak. Jangan pernah memodifikasi steker. Jangan menggunakan steker adaptor bersama dengan perangkat listrik yang terhubung dengan sistem grounding.** Steker yang tidak dimodifikasi dan stopkontak yang cocok akan mengurangi risiko sengatan listrik.
- ▶ **Hindari kontak badan dengan permukaan yang terhubung dengan sistem grounding, seperti pipa, radiator, kompor, dan lemari es.** Terdapat peningkatan risiko terjadinya sengatan listrik jika badan Anda terhubung dengan sistem grounding.
- ▶ **Perkakas listrik tidak boleh terpapar hujan atau basah.** Air yang masuk ke dalam perangkat listrik menambah risiko terjadinya sengatan listrik.
- ▶ **Jangan menyalahgunakan kabel. Jangan gunakan kabel untuk membawa, menarik, atau melepas steker perangkat listrik. Jauhkan kabel dari panas, minyak, tepi yang tajam, atau komponen yang bergerak.** Kabel listrik yang rusak atau tersangkut menambah risiko terjadinya sengatan listrik.
- ▶ **Saat mengoperasikan perangkat listrik di luar ruangan, gunakan kabel ekstensi yang sesuai untuk penggunaan di luar ruangan.** Penggunaan kabel yang cocok untuk pemakaian di luar ruangan mengurangi risiko terjadinya sengatan listrik.
- ▶ **Jika perangkat listrik memang harus dioperasikan di tempat yang lembap, gunakan pemutus arus listrik residu (RCD).** Penggunaan RCD akan mengurangi risiko terjadinya sengatan listrik.

Keselamatan personel

- ▶ **Tetap waspada, perhatikan aktivitas yang sedang dikerjakan, dan gunakan akal sehat saat mengoperasikan perangkat listrik. Jangan gunakan perangkat listrik saat mengalami kelelahan atau di bawah pengaruh narkoba, alkohol, atau obat-obatan.** Jika perangkat listrik dioperasikan dengan daya

konsentrasi yang rendah, hal tersebut dapat menyebabkan cedera serius.

- ▶ **Gunakan peralatan pelindung diri. Selalu kenakan pelindung mata.** Dengan memakai pakaian dan sarana pelindung, misalnya masker anti debu, sepatu tertutup yang tidak licin, helm pelindung, atau pemalut telinga sesuai dengan pekerjaan yang dilakukan, hal tersebut dapat mengurangi risiko cedera.
- ▶ **Hindari start yang tidak disengaja. Pastikan switch berada di posisi off sebelum perkakas listrik dihubungkan ke sumber daya listrik dan/atau baterai, diangkat, atau dibawa.** Membawa perkakas listrik dengan jari menempel pada tombol atau perkakas listrik dalam keadaan hidup dapat memicu kecelakaan.
- ▶ **Singkirkan kunci penyetel atau kunci pas sebelum menghidupkan perkakas listrik.** Perkakas atau kunci pas yang masih menempel pada komponen perkakas listrik yang berputar dapat menyebabkan cedera.
- ▶ **Jangan melampaui batas. Berdirilah secara mantap dan selalu jaga keseimbangan.** Hal ini akan memberikan kontrol yang lebih baik terhadap perkakas listrik pada situasi yang tak terduga.
- ▶ **Kenakan pakaian dengan wajar. Jangan mengenakan perhiasan atau pakaian yang longgar. Jauhkan rambut, pakaian, dan sarung tangan dari bagian-bagian perkakas yang bergerak.** Pakaian yang longgar, rambut panjang atau perhiasan dapat tersangkut dalam bagian perkakas yang bergerak.
- ▶ **Jika disediakan perangkat untuk sambungan pengisapan debu dan alat pengumpulan, pastikan perangkat tersebut terhubung dan digunakan dengan benar.** Penggunaan alat pengumpulan dapat mengurangi bahaya yang disebabkan oleh debu.

Penggunaan dan pemeliharaan perkakas listrik

- ▶ **Jangan memaksakan perkakas listrik. Gunakan perkakas listrik yang sesuai untuk pekerjaan yang dilakukan.** Perkakas listrik yang sesuai akan bekerja dengan lebih baik dan aman sesuai tujuan penggunaan.
- ▶ **Jangan gunakan perkakas listrik dengan switch yang tidak dapat dioperasikan.** Perkakas listrik yang switchnya tidak berfungsi dapat menimbulkan bahaya dan harus diperbaiki.
- ▶ **Tariklah steker dari stopkontak dan/atau keluarkan baterai sebelum melakukan penyetelan pada perkakas listrik, penggantian aksesoris atau sebelum menyimpan perkakas listrik.** Tindakan keselamatan kerja ini mengurangi risiko perkakas listrik beroperasi secara tiba-tiba.
- ▶ **Jauhkan dan simpan perkakas listrik dari jangkauan anak-anak dan jangan biarkan orang-orang yang tidak mengetahui cara menggunakan perkakas listrik, mengoperasikan perkakas listrik.** Perkakas listrik dapat membahayakan jika digunakan oleh orang-orang yang tidak terlatih.
- ▶ **Rawatlah perkakas listrik. Periksa komponen yang bergerak apabila tidak lurus atau terikat, kerusakan**

komponen, dan kondisi lain yang dapat mengganggu pengoperasian perkakas listrik. Apabila rusak, perbaiki perkakas listrik sebelum digunakan. Banyak kecelakaan terjadi karena perkakas listrik tidak dirawat dengan seksama.

- ▶ **Jaga ketajaman dan kebersihan alat.** Alat pemotong dengan pisau pemotong yang tajam dan dirawat dengan baik tidak akan mudah tersangkut dan lebih mudah dikendalikan.
- ▶ **Gunakan perkakas listrik, aksesoris, dan komponen perkakas dll sesuai dengan petunjuk ini, dengan mempertimbangkan kondisi kerja dan pekerjaan yang akan dilakukan.** Penggunaan perkakas listrik untuk tujuan berbeda dari fungsinya dapat menyebabkan situasi yang berbahaya.

Penggunaan dan pemeliharaan perkakas baterai

- ▶ **Isi ulang daya hanya dengan pengisi daya yang ditentukan oleh produsen.** Pengisi daya yang sesuai untuk satu jenis set baterai dapat menyebabkan risiko kebakaran apabila digunakan dengan set baterai lain.
- ▶ **Hanya gunakan perkakas listrik dengan set baterai yang dirancang khusus.** Penggunaan set baterai lain dapat menyebabkan risiko cedera dan kebakaran.
- ▶ **Apabila set baterai tidak digunakan, jauhkan dari benda logam lainnya, seperti klip kertas, koin, kunci, paku, sekrup, atau benda logam kecil lainnya yang dapat membuat sambungan dari satu terminal ke terminal lainnya.** Memendekkan terminal baterai dapat menyebabkan kebakaran atau api.
- ▶ **Cairan dapat keluar dari baterai jika baterai tidak digunakan dengan benar; hindari kontak. Jika terjadi kontak secara tidak disengaja, bilas dengan air. Jika cairan mengenai mata, segera hubungi bantuan medis.** Cairan yang keluar dari baterai dapat menyebabkan iritasi atau luka bakar.

Servis

- ▶ **Minta teknisi berkualifikasi untuk menyervis perkakas listrik dengan hanya menggunakan suku cadang yang identik.** Dengan demikian, hal ini akan memastikan keamanan perkakas listrik.

Petunjuk keselamatan untuk gerinda sudut

Petunjuk Keselamatan umum untuk Menggerinda, Mengampelas, Menyikat, atau Pemotongan Abrasif

- ▶ **Perkakas listrik ini dirancang untuk menggerinda, mengampelas, menyikat, atau memotong. Baca semua peringatan, petunjuk, ilustrasi, dan spesifikasi keselamatan yang diberikan bersama perkakas listrik ini.** Kesalahan dalam menjalankan petunjuk-petunjuk untuk keselamatan kerja di bawah ini dapat mengakibatkan kontak listrik, kebakaran dan/atau luka berat.
- ▶ **Pekerjaan seperti memoles tidak dianjurkan untuk dikerjakan dengan perkakas listrik ini.** Penggunaan perkakas listrik yang tidak sesuai dengan yang dianjurkan dapat menimbulkan risiko cedera.

- ▶ **Jangan gunakan aksesoris yang tidak dirancang secara khusus dan dianjurkan oleh produsen perkakas.** Meski aksesoris dapat dipasang pada perkakas listrik, hal ini tidak menjamin keamanan pengoperasian alat.
- ▶ **Ukuran kecepatan aksesoris setidaknya harus sama dengan kecepatan maksimum yang tertera pada perkakas listrik.** Aksesoris yang beroperasi lebih cepat dari ukuran kecepatan yang tertera dapat rusak dan terlepas.
- ▶ **Diameter dan ketebalan luar aksesoris harus dalam kapasitas perkakas listrik.** Aksesoris yang ukurannya salah tidak dapat dikendalikan dan ditanggung keamanannya.
- ▶ **Penopang berulir pada aksesoris harus sesuai dengan ulir poros gerinda. Untuk aksesoris yang dipasang dengan flensa, lubang pengeboran aksesoris harus sesuai dengan diameter posisi flensa.** Aksesoris yang tidak sesuai dengan perangkat keras yang terpasang pada perkakas listrik akan kehilangan keseimbangan, bergetar terlalu keras dan kehilangan kendali.
- ▶ **Jangan gunakan aksesoris yang sudah rusak. Sebelum digunakan, periksa aksesoris, seperti cakram abrasif dari kepingan dan keretakan, bantalan penyokong dari keretakan, keausan atau penggunaan berlebihan, sikat kawat yang kendur atau kabel yang retak. Jika perkakas listrik atau aksesoris terjatuh, periksa perkakas dari kerusakan atau pasang aksesoris yang tidak rusak. Setelah memeriksa dan memasang aksesoris, jaga jarak Anda dari bidang aksesoris yang berputar dan jalankan perkakas dengan kecepatan maksimum tanpa beban selama satu menit.** Aksesoris yang rusak biasanya akan hancur saat dilakukan pengujian ini.
- ▶ **Kenakan alat pelindung. Tergantung pada pemakaian, gunakan pelindung wajah, kaca mata pelindung, atau kaca mata keamanan. Kenakan masker debu, pelindung pendengaran, sarung tangan dan pakaian kerja yang mampu melindungi dari material kecil atau kepingan benda kerja.** Pelindung mata harus mampu melindungi dari puing-puing yang terbang selama pemakaian. Masker debu atau respirator harus mampu menyaring partikel yang dihasilkan saat pemakaian perkakas. Pemakaian terlalu lama hingga menimbulkan kebisingan yang sangat tinggi dapat menimbulkan kehilangan pendengaran.
- ▶ **Hendaklah pengamat memberi jarak aman dengan area kerja. Siapa saja yang memasuki area kerja harus memakai alat pelindung.** Bagian dari alat kerja atau aksesoris yang rusak dapat terlempar dan menyebabkan cedera di luar area langsung pengoperasian.
- ▶ **Pegang perkakas listrik hanya pada permukaan gagang isolator saat melakukan pengerjaan yang memungkinkan aksesoris pemotong bersentuhan dengan kabel yang tidak terlihat.** Aksesoris pemotong yang bersentuhan dengan kabel yang dialiri listrik dapat menyebabkan bagian logam perkakas listrik yang terbuka

dialiri listrik sehingga berisiko mengakibatkan sengatan listrik pada operator.

- ▶ **Jangan pernah letakkan perkakas listrik sebelum aksesoris telah berhenti sepenuhnya.** Aksesoris yang berputar dapat menabrak permukaan dan perkakas lepas dari kendali Anda.
- ▶ **Jangan menghidupkan perkakas listrik dengan membawanya ke samping Anda.** Kontak tidak sengaja dengan aksesoris yang berputar dapat merobek pakaian, menarik aksesoris ke tubuh Anda.
- ▶ **Bersihkan ventilasi udara pada perkakas listrik secara berkala.** Kipas motor akan menyerap debu ke dalam housing dan serbuk logam yang terlalu banyak terkumpul dapat menyebabkan bahaya listrik.
- ▶ **Jangan gunakan perkakas listrik ini berdekatan dengan material yang mudah terbakar.** Percikan api dapat membakar material-material tersebut.
- ▶ **Jangan gunakan aksesoris yang memakai pendingin cair.** Menggunakan air atau pendingin cair lainnya dapat menyebabkan sengatan atau kejut listrik.

Sentakan dan Peringatan Terkait

Sentakan merupakan reaksi tiba-tiba pada cakram yang berputar, terjepit atau tersangkut, bantalan penyokong, sikat atau aksesoris lainnya. Cakram yang terjepit atau tersangkut menyebabkan aksesoris yang berputar akan berhenti mendadak dan menyebabkan perkakas yang tak terkendali berputar ke arah sebaliknya dari putaran aksesoris pada titik belitan.

Sebagai contoh, jika sebuah cakram abrasif tersangkut atau terjepit benda kerja, tepi cakram yang masuk ke titik jepit dapat masuk ke dalam permukaan material yang menyebabkan cakram naik atau terlempar ke luar. Cakram dapat terlempar menjauh maupun ke arah operator, bergantung pada arah gerakan cakram pada titik jepitan. Cakram abrasif juga dapat rusak karena hal-hal ini. Sentakan merupakan akibat dari penggunaan yang salah dari perkakas listrik ini dan/atau prosedur atau syarat pengoperasian atau syarat-syarat penggunaan yang tidak tepat, namun dapat dihindari dengan melakukan tindakan pencegahan yang tepat seperti yang diberikan di bawah ini.

- ▶ **Pegang gagang perkakas listrik dan posisikan tubuh dan lengan Anda agar dapat menahan daya sentakan. Jika disediakan, selalu gunakan handle tambahan sebagai kendali maksimum melawan sentakan atau efek torsi saat menghidupkan.** Operator dapat mengendalikan efek torsi atau gaya sentakan bila melakukan tindakan pencegahan.
- ▶ **Jauhkan tangan Anda dari aksesoris yang berputar.** Aksesoris dapat memberikan sentakan terhadap tangan Anda.
- ▶ **Jangan berdiri di tempat perkakas bergerak saat terjadi sentakan.** Sentakan akan bergerak ke arah berlawanan dari gerakan cakram pada titik sangkut.
- ▶ **Lakukan dengan hati-hati saat bekerja untuk bagian sudut, tepi yang tajam, dll. Hindarkan aksesoris dari risiko terlempar atau tersangkut.** Bagian sudut, tepi yang tajam atau melingkar berpotensi membuat aksesoris

yang berputar tersangkut dan menimbulkan hilangnya kendali atau sentakan.

- ▶ **Jangan pasang pisau pengukir kayu atau gergaji bergigi.** Jenis pisau tersebut dapat menimbulkan sentakan dan kehilangan kendali.

Petunjuk Keselamatan khusus untuk Menggerinda dan Memotong Abrasif

- ▶ **Hanya gunakan jenis cakram yang dianjurkan untuk perkakas listrik Anda dan pelindung khusus yang dirancang untuk cakram yang dipilih.** Cakram yang tidak dirancang untuk perkakas listrik, tidak dapat dijamin keamanan dan keselamatannya.
- ▶ **Permukaan gerinda dari cakram dengan bagian tengah ditekan harus dipasang di bawah pengetam mulut pelindung.** Pemasangan cakram yang salah yang menjorok ke pengetam pada mulut pelindung tidak dapat terlindung dengan baik.
- ▶ **Pelindung harus terpasang ke perkakas listrik dengan aman dan berada pada posisi keamanan maksimal, sehingga hanya sebagian kecil cakram yang mengarah ke operator.** Pelindung akan membantu melindungi operator dari kepingan-kepingan cakram yang pecah, kontak secara tidak sengaja dengan cakram dan percikan yang dapat membakar baju yang dipakai.
- ▶ **Cakram harus digunakan sesuai dengan pemakaian yang dianjurkan.** Misalnya: jangan menggerinda dengan sisi cakram pemotong. Cakram pemotong abrasif digunakan untuk menggerinda bagian tepi, gaya di sisi cakram dapat menyebabkan cakram pecah.
- ▶ **Selalu gunakan flensa cakram yang tidak rusak dengan ukuran dan bentuk yang sesuai untuk cakram yang dipilih.** Flensa cakram yang tepat akan membantu cakram mengurangi kemungkinan kerusakan cakram. Flensa untuk cakram pemotong dapat berbeda dengan flensa cakram gerinda.
- ▶ **Jangan gunakan cakram yang telah usang dari perkakas listrik yang lebih besar.** Cakram untuk perkakas listrik yang lebih besar tidak cocok untuk perkakas yang lebih kecil dengan kecepatan lebih tinggi dan dapat menimbulkan ledakan.

Petunjuk Keselamatan Tambahan khusus untuk Pemotongan Abrasif

- ▶ **Jangan "menyumbat" cakram pemotong atau menggunakan tekanan yang terlalu tinggi. Jangan memotong terlalu dalam.** Tekanan yang terlalu tinggi pada cakram akan meningkatkan beban dan kerentanan terhadap putaran atau ikatan cakram dalam memotong, dan kemungkinan terjadinya sentakan atau kerusakan cakram.
- ▶ **Jangan posisikan tubuh Anda di belakang dan sejajar dengan cakram yang berputar.** Ketika cakram, pada saat digunakan, bergerak menjauh dari tubuh Anda, sentakan dapat mendorong cakram yang berputar dan perkakas secara langsung ke arah Anda.
- ▶ **Ketika cakram terbelit atau ketika pemotongan terhenti oleh suatu sebab, matikan perkakas dan**

pegang perkakas tanpa gerakan hingga perkakas benar-benar mati. Jangan pernah mencoba melepas cakram pemotong ketika cakram sedang berputar. Jika tidak, dapat terjadi sentakan. Periksa dan lakukan reparasi untuk mengatasi penyebab cakram tersangkut.

- ▶ **Jangan melanjutkan pemotongan saat perkakas berada dalam benda kerja. Biarkan cakram berputar dengan kecepatan penuh dan lanjutkan memotong dengan hati-hati.** Cakram dapat terbelit, maju, atau mundur jika perkakas listrik dihidupkan kembali dalam benda kerja.
- ▶ **Pelat penyangga atau benda kerja yang berukuran sangat besar digunakan untuk mengurangi risiko cakram tersangkut atau mengalami sentakan.** Benda kerja yang besar cenderung akan merosot akibat besarnya beban. Penyangga harus ditempatkan di bawah benda kerja dekat dengan garis potong dan dekat tepi benda kerja pada kedua sisi cakram.
- ▶ **Lakukan dengan hati-hati saat membuat potongan dalam dinding (pocket cut) atau area yang sulit dijangkau lainnya.** Cakram yang menonjol dapat memotong pipa gas atau air, kabel listrik, atau benda yang dapat menimbulkan sentakan.

Petunjuk Keselamatan khusus untuk Pengampelasan

- ▶ **Jangan gunakan kertas ampelas yang berukuran terlalu besar. Ikuti rekomendasi produsen ketika memilih kertas ampelas.** Kertas ampelas yang terlalu besar melebihi bidang pengampelasan akan menimbulkan goresan, dan dapat menyebabkan belitan, cabikan pada cakram, atau sentakan.

Petunjuk Keselamatan khusus untuk Menyikat

- ▶ **Hati-hati bulu kawat terlepas oleh sikat meski saat pemakaian biasa. Jangan terlalu membebani kawat dengan memberi beban yang berlebih pada sikat** Kawat dapat menembus kain atau/dan kulit dengan mudah.
- ▶ **Jika penggunaan pelindung dianjurkan untuk menyikat, jangan biarkan cakram atau sikat kawat terganggu karena pemakaian pelindung.** Diameter cakram atau sikat kawat dapat mengembang akibat beban kerja dan gaya sentrifugal.

Petunjuk Keselamatan tambahan

Pakailah kaca mata pelindung.



- ▶ **Gunakanlah alat detektor logam yang cocok untuk mencari kabel dan pipa yang tidak terlihat atau hubungi perusahaan pengadaan setempat.** Sentuhan dengan kabel-kabel listrik dapat mengakibatkan api dan kontak listrik. Pipa gas yang dirusak dapat mengakibatkan ledakan. Pipa air yang dirusak mengakibatkan barang-barang menjadi rusak.
- ▶ **Jangan memegang mata gerinda dan mata potong sebelum alat-alat tersebut menjadi dingin.** Piringan-

piringan ini menjadi sangat panas selama penggunaannya.

► **Buka kunci tombol on/off dan setel ke posisi off saat aliran listrik terputus, misalnya akibat baterai dilepas.**

Dengan demikian, perkasas listrik tidak hidup kembali secara tidak terkendali.

► **Gunakan alat kerja dengan aman.** Benda yang ditahan dalam alat pemegang atau bais lebih aman daripada benda yang dipegang dengan tangan.

► **Asap dapat keluar apabila terjadi kerusakan atau penggunaan yang tidak tepat pada baterai. Baterai dapat terbakar atau meledak.** Biarkan udara segar mengalir masuk dan kunjungi dokter apabila mengalami gangguan kesehatan. Asap tersebut dapat mengganggu saluran pernafasan.

► **Jangan membuka baterai.** Ada bahaya terjadinya korsleting.

► **Baterai dapat rusak akibat benda-benda lancip, seperti jarum, obeng, atau tekanan keras dari luar.** Hal ini dapat menyebabkan terjadinya hubungan singkat internal dan baterai dapat terbakar, berasap, meledak, atau mengalami panas berlebih.

► **Hanya gunakan baterai pada produk yang dibuat oleh produsen.** Hanya dengan cara ini, baterai dapat terlindung dari kelebihan muatan.



Lindungi baterai dari panas, misalnya juga dari paparan sinar matahari dalam waktu yang lama, api, kotoran, air dan kelembapan. Terdapat risiko ledakan dan korsleting.



► **Waspada! Ketika menggunakan perkakas listrik dengan Bluetooth®, gangguan dapat muncul pada perangkat dan instalasi lain, pesawat terbang, dan perangkat medis (misalnya alat pacu jantung, alat bantu dengar. Selain itu, cedera pada manusia dan binatang di area sekitar tidak dapat seluruhnya dihindari. Jangan menggunakan alat pengukur dengan Bluetooth® di dekat perangkat medis, pusat pengisian bahan bakar, instalasi kimia, area dengan bahaya ledakan, dan percikan api. Jangan menggunakan perkakas listrik dengan Bluetooth® di dalam pesawat terbang. Hindari pengoperasian di dekat kepala secara langsung dalam waktu yang lama.**

Istilah merek *Bluetooth®* serta gambar simbol (logo) merupakan merek dagang terdaftar dan kepemilikan dari Bluetooth SIG, Inc. Setiap penggunaan istilah merek/gambar simbol ini berada di bawah lisensi Robert Bosch Power Tools GmbH.

Spesifikasi produk dan performa



Bacalah semua petunjuk keselamatan dan petunjuk penggunaan. Kesalahan dalam menjalankan petunjuk keselamatan dan petunjuk penggunaan dapat mengakibatkan kontak listrik, kebakaran, dan/atau luka-luka

yang berat.

Perhatikan ilustrasi yang terdapat pada sisi sampul panduan pengoperasian.

Tujuan penggunaan

Perkasas listrik ini cocok untuk memotong, mengikis dan menyikat bahan-bahan logam dan batu-batuan tanpa menggunakan air.

Untuk memotong dengan bahan yang kasar, diperlukan sebuah kap pelindung khusus untuk memotong.

Untuk memotong batu-batuan, penghisapan debu yang memadai perlu diperhatikan.

Dengan alat kerja yang diperbolehkan, perkasas listrik dapat digunakan untuk melakukan penggerindaan dengan kertas amplas.

Data dan pengaturan perkasas listrik dapat dikirimkan menggunakan modul *Bluetooth®* Low Energy **GCY 42** yang terpasang dengan menggunakan teknologi nirkabel *Bluetooth®* antara perkasas listrik dan perangkat seluler.

Ilustrasi komponen

Nomor-nomor dari bagian-bagian perkasas pada gambar sesuai dengan gambar perkasas listrik pada halaman bergambar.

- (1) Tuas pelepas kunci untuk kap pelindung
- (2) Panah arah putaran pada housing
- (3) Tombol pengunci spindel
- (4) User Interface
- (5) Tombol on/off
- (6) Penutup modul *Bluetooth®* Low Energy GCY 42
- (7) Baterai^{A)}
- (8) Tombol pelepas baterai^{A)}
- (9) Gagang tambahan (permukaan genggam berisolator)
- (10) Kap pelindung untuk menggerinda
- (11) Flensa pemasangan dengan ring-O
- (12) Mata gerinda
- (13) Mur penjepit
- (14) Mata gerinda karbida^{A)}
- (15) Kap pelindung untuk memotong^{A)}
- (16) Cakram pemotong^{A)}
- (17) Gagang (permukaan genggam berisolator)
- (18) Spindel gerinda
- (19) Pelindung tangan^{A)}
- (20) Piringan gerinda karet^{A)}
- (21) Kertas ampelas^{A)}
- (22) Mur bulat^{A)}
- (23) Sikat kawat berbentuk mangkuk^{A)}
- (24) Bit inti intan^{A)}
- (25) Indikator level pengisian daya baterai (User Interface)
- (26) Display kickback stop (User Interface)
- (27) Tombol untuk pemilihan awal kecepatan putaran (User Interface)

- (28) Display mode/tingkat kecepatan (User Interface)
- (29) Display smartphone (User Interface)
- (30) Display status perkakas listrik (User Interface)
- (31) Display suhu (User Interface)

(32) Flap wheel^{A)}

- A) **Aksesori yang ada pada gambar atau yang dijelaskan tidak termasuk dalam lingkup pengiriman standar. Semua aksesori yang ada dapat Anda lihat dalam program aksesori kami.**

Data teknis

Mesin gerinda sudut		GWS 18V-15 C	GWS 18V-15 SC
Nomor seri		3 601 JH6 0..	3 601 JH6 1..
Tegangan nominal	V=	18	18
Kecepatan nominal ^{A)}	min ⁻¹	11000	11000
Kecepatan idle ^{B)}	min ⁻¹	9800	3400–9800
Diameter mata gerinda maks.	mm	100	100
Ulir spindel gerinda		M 10	M 10
Panjang ulir spindel gerinda maks.	mm	16	16
Kickback stop (pengaman terhadap bantingan)		●	●
Pelindung terhadap start ulang		●	●
Rem run out		●	●
Pemilihan awal kecepatan putaran		–	●
Berat sesuai dengan EPTA-Procedure 01:2014 ^{C)}			
– dengan gagang tambahan peredam getaran	kg	2,5–3,5	2,5–3,5
– dengan gagang tambahan standar	kg	2,3–3,3	2,3–3,3
Suhu sekitar yang direkomendasikan saat pengisian daya	°C	0...+35	0...+35
Suhu sekitar yang diizinkan saat pengoperasian ^{D)} dan saat disimpan	°C	–20...+50	–20...+50
Baterai yang kompatibel		GBA 18V... ProCORE18V...	GBA 18V... ProCORE18V...
Baterai yang direkomendasikan untuk performa penuh		ProCORE18V... ≥ 5,5 Ah	ProCORE18V... ≥ 5,5 Ah
Perangkat pengisian daya yang direkomendasikan		GAL 18... GAX 18... GAL 36...	GAL 18... GAX 18... GAL 36...

Pengiriman data

<i>Bluetooth</i> [*]		<i>Bluetooth</i> [®] 4.2 (Low Energy) ^{E)}	<i>Bluetooth</i> [®] 4.2 (Low Energy) ^{E)}
Jarak sinyal	s	8	8
Jangkauan sinyal maksimal ^{F)}	m	30	30

A) Nilai kecepatan putaran menurut norma EN 60745-2-3

B) Diukur pada suhu 20–25°C dengan baterai ProCORE18V 8.0Ah dan bergantung pada status daya baterai serta suhu pengoperasian perangkat

C) tergantung pada baterai yang digunakan

D) daya terbatas pada suhu <0 °C

E) Perangkat seluler harus kompatibel dengan perangkat *Bluetooth*[®] Low Energy (versi 4.2) dan mendukung Generic Access Profile (GAP).

F) Jangkauan sinyal dapat berbeda-beda bergantung pada kondisi di luar serta perangkat penerima yang digunakan. Jangkauan *Bluetooth*[®] dapat sangat lemah jika berada di dalam ruangan tertutup dan melewati penghalang logam (contoh dinding, rak, koper, dll.).

Pemasangan

Memasang modul **Bluetooth® Low Energy GCY 42**

Catatan: Pada perkakas listrik GWS 18V-15 C, modul **Bluetooth® Low Energy GCY 42** tersedia sebagai aksesori; namun sudah termasuk dalam lingkup pengiriman pada perkakas listrik GWS 18V-15 SC.

Untuk informasi mengenai modul **Bluetooth® Low Energy GCY 42**, baca panduan pengoperasian terkait.

Mengisi daya baterai

- ▶ **Hanya gunakan pengisi daya yang tercantum pada data teknis.** Hanya pengisi daya ini yang sesuai dengan baterai Li-ion yang digunakan pada perkakas listrik Anda.

Catatan: Baterai dikirim dalam keadaan terisi sebagian. Untuk memastikan kinerja penuh baterai, isi penuh daya baterai ke pengisi daya sebelum menggunakannya untuk pertama kali.

Daya baterai li-ion dapat diisi setiap saat tanpa mengurangi masa pakainya. Penghentian proses pengisian daya tidak merusak baterai.

Baterai li-ion terlindung dari pengosongan daya total dengan "Electronic Cell Protection (ECP)". Jika baterai habis, perkakas listrik dimatikan oleh pengaman: Alat sisipan berhenti beroperasi.

- ▶ **Jangan menekan kembali tombol on/off jika perkakas listrik mati secara otomatis.** Baterai dapat rusak. Perhatikan petunjuk mengenai pemuangan baterai.



Melepaskan baterai

Baterai (7) memiliki dua level penguncian untuk mencegah baterai terlepas saat tombol pelepas baterai (8) ditekan secara tidak sengaja. Selama baterai berada di dalam perkakas listrik, baterai ditahan dalam dudukannya dengan pegas.

Untuk melepas baterai (7), tekan tombol pelepas (8) dan tarik baterai dari perkakas listrik. **Jangan melepas baterai dengan paksa.**

Indikator level pengisian daya baterai

LED berwarna hijau dari indikator level pengisian daya baterai menampilkan level pengisian daya baterai. Atas dasar keselamatan, permintaan level pengisian daya baterai hanya dapat dilakukan saat perkakas listrik dalam keadaan berhenti.

Tekan tombol indikator level pengisian daya baterai  atau  untuk menampilkan level pengisian baterai. Hal ini juga dapat dilakukan saat baterai dilepas.

Apabila LED tidak menyala setelah menekan tombol indikator level pengisian daya, terdapat kerusakan pada baterai dan baterai harus diganti.

Catatan: Level pengisian daya baterai juga ditampilkan pada User Interface (4) (lihat „Display status“, Halaman 70).

Tipe baterai GBA 18V...



LED	Kapasitas
Lampu permanen 3× hijau	60–100 %
Lampu permanen 2× hijau	30–60 %
Lampu permanen 1× hijau	5–30 %
Lampu berkedip 1× hijau	0–5 %

Tipe baterai ProCORE18V...



LED	Kapasitas
Lampu permanen 5× hijau	80–100 %
Lampu permanen 4× hijau	60–80 %
Lampu permanen 3× hijau	40–60 %
Lampu permanen 2× hijau	20–40 %
Lampu permanen 1× hijau	5–20 %
Lampu berkedip 1× hijau	0–5 %

Memasang komponen pelindung

- ▶ **Sebelum melakukan semua pekerjaan pada perkakas listrik (misalnya merawat, mengganti alat kerja, dsb.) serta selama transpor dan penyimpanan, keluarkanlah baterai dari perkakas listrik.** Terdapat risiko cedera apabila tombol untuk menghidupkan dan mematikan dioperasikan tanpa sengaja.

Catatan: Jika mata gerinda mengalami kerusakan selama penggunaan atau jika peralatan pemasangan pada kap pelindung/ perkakas listrik rusak, peralatan listrik harus segera dikirimkan ke Service Center. Alamat pengiriman dapat dilihat di bab "Service Center dan konsultasi penggunaan".

Kap pelindung untuk menggerinda

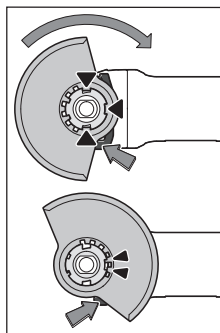

Letakkan kap pelindung (10) padaudukan perkakas listrik hingga nok penempatan kap pelindung sesuai dengan dudukannya. Tekan dan tahan tuas pelepas kunci (1). Tekan kap pelindung (10) pada leher spindel hingga ikat kap pelindung terpasang pada flensa perkakas listrik dan putar kap pelindung hingga terdengar terkunci. Sesuaikan posisi kap pelindung (10) dengan

persyaratan pengoperasian. Tekan tuas pelepas kunci (1) ke atas dan putar kap pelindung (10) ke posisi yang diinginkan.

- ▶ **Selalu atur kap pelindung (10) sedemikian rupa sehingga kedua nok tuas pelepas kunci (1) terkait pada lekuk kap pelindung yang sesuai (10) .**
- ▶ **Atur kap pelindung (10) sedemikian rupa agar bunga api tidak memercik ke arah pengguna.**
- ▶ **Kap pelindung (10) hanya boleh diputar dengan mengoperasikan tuas pelepas kunci (1)! Jika tidak, perkakas listrik tidak boleh digunakan kembali dalam kondisi apa pun dan harus diserahkan ke layanan pelanggan.**

Catatan: Nok penempatan pada kap pelindung (10) memastikan agar hanya kap pelindung yang sesuai untuk perkakas listrik yang dapat dipasang.

Kap pelindung untuk memotong

- ▶ **Saat memotong dengan bahan yang kasar, selalu pasang kap pelindung untuk memotong (15).**
- ▶ **Perhatikan penghisapan debu yang memadai saat memotong bahan batu-batuan.**

Pasang kap pelindung untuk memotong (15) seperti memasang kap pelindung untuk menggerinda (10).

Gagang tambahan

- ▶ **Hanya gunakan perkakas listrik dengan gagang tambahan (9).**

Pasang gagang tambahan (9) di sebelah kanan atau kiri dari kepala mesin, bergantung dari pekerjaan yang dilakukan.

Gagang tambahan yang dapat meredam getaran



Gagang tambahan yang meredam getaran akan mengurangi vibrasi yang terjadi sehingga pekerjaan

menjadi lebih nyaman dan aman.

- ▶ **Janganlah sekali-kali mengubah gagang tambahan.**

Gagang tambahan yang rusak tidak boleh digunakan kembali.

Pelindung tangan

- ▶ **Saat melakukan pekerjaan dengan piringan karet (20) atau dengan mangkuk sikat kawat/piringan sikat/piringan dengan ampelas yang berlapis-lapis, pasang selalu pelindung tangan (19).**

Kencangkan pelindung tangan (19) bersama dengan gagang tambahan(9).

Memasang alat kerja

- ▶ **Sebelum melakukan semua pekerjaan pada perkakas listrik (misalnya merawat, mengganti alat kerja, dsb.) serta selama transpor dan penyimpanan, keluarkanlah baterai dari perkakas listrik.** Terdapat risiko cedera apabila tombol untuk menghidupkan dan mematikan dioperasikan tanpa sengaja.
- ▶ **Jangan memegang mata gerinda dan mata potong sebelum alat-alat tersebut menjadi dingin.** Piringan-piringan ini menjadi sangat panas selama penggunaannya.

Bersihkan spindel gerinda (18) dan semua bagian yang akan dipasang .

Untuk memasang dan melepas alat kerja, tekan tombol penahan spindel (3), untuk menahan spindel gerinda.

- ▶ **Hanya gerakkan tombol penahan spindel gerinda jika spindel tidak berputar.** Jika tidak, perkakas listrik dapat rusak.

Mata gerinda/cakram potong

Perhatikanlah ukuran alat gerinda. Diameter lubang harus sesuai dengan flensa pemasangan. Jangan menggunakan adaptor atau reducer.

Saat menggunakan cakram potong intan, pastikan bahwa tanda panah arah putaran pada cakram potong intan dan arah putaran perkakas listrik (lihat tanda panah arah putaran pada kepala gigi) telah sesuai.

Urutan pemasangannya terlihat pada halaman bergambar.

Untuk memasang cakram gerinda/cakram potong, pasang mur penjepit (13) dan kencangkan dengan kunci lubang ganda.

- ▶ **Setelah memasang alat kerja dan menghidupkan perkakas, periksa apakah alat kerja sudah dipasangkan dengan benar dan dapat berputar secara bebas. Perhatikan agar alat kerja tidak menyinggung kap pelindung atau bagian-bagian lainnya.**

Piringan dengan ampelas yang berlapis-lapis

- ▶ **Untuk pekerjaan dengan piringan dengan ampelas yang berlapis-lapis, selalu pasang pelindung tangan (19).**

Cakram gerinda karet

- ▶ **Untuk pekerjaan dengan piringan karet (20) , selalu pasang pelindung tangan(19).**

Urutan pemasangannya terlihat pada halaman bergambar.

Geser piringan gerinda karet (20) ke spindel gerinda (18).

Tekan kertas ampelas (21) dengan kuat ke sisi bawah piringan gerinda karet (20).

Pasang mur bulat (22) dan kencangkan dengan kunci lubang ganda.

Sikat kawat berbentuk mangkuk/piringan sikat

- ▶ **Untuk pekerjaan dengan sikat kawat berbentuk mangkuk/piringan sikat, selalu pasang pelindung tangan (19).**

Urutan pemasangannya terlihat pada halaman bergambar.

Sikat kawat berbentuk mangkuk/piringan sikat harus dipasang sedemikian rupa pada spindel gerinda sehingga sikat benar-benar terpasang pada flensa spindel gerinda pada ujung ulir spindel gerinda. Kencangkan sikat kawat/piringan sikat dengan kunci pas.

Roda gerinda karbida





- ▶ **Penggunaan roda gerinda hanya diperbolehkan dengan kap pelindung yang sesuai.**

Alat gerinda yang diperbolehkan

Semua alat kerja yang disebutkan di dalam petunjuk pengoperasian ini dapat digunakan.

Kecepatan putaran yang diizinkan [min^{-1}] atau kecepatan lingkaran [m/s] dari alat kerja yang digunakan setidaknya harus sesuai dengan informasi yang tertera pada tabel.

Oleh karena itu, perhatikan **kecepatan putaran atau kecepatan lingkaran** yang diizinkan pada label alat kerja.

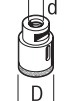
	maks. [mm]	[mm]		
	D	b	d	[min^{-1}] [m/s]
	100	7	16	11000 80
	100	-	-	11000 80
	75	30	M 14	11000 45
	82	-	M 14	11000 80

Memutar kepala mesin (GWS 18V-15 C)

- **Sebelum melakukan semua pekerjaan pada perkakas listrik (misalnya merawat, mengganti alat kerja, dsb.) serta selama transpor dan penyimpanan, keluarkanlah baterai dari perkakas listrik.** Terdapat risiko cedera apabila tombol untuk menghidupkan dan mematikan dioperasikan tanpa sengaja.

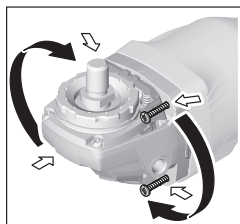

Kepala mesin dapat diputar 90° dalam setiap interval. Dengan demikian, tombol on/off dapat digunakan ke posisi yang lebih nyaman dalam situasi pengerjaan khusus, misalnya bagi pengguna bertangan kidal. Lepaskan keempat baut. Gerakkan kepala mesin

dengan hati-hati ke posisi baru **tanpa melepaskannya dari housing**. Pasang dan kencangkan kembali keempat baut.

Pengisapan debu/serbuk

Debu dari bahan-bahan seperti cat yang mengandung timbel (timah hitam), beberapa jenis kayu, bahan mineral dan logam dapat berbahaya bagi kesehatan. Menyentuh atau menghirup debu-debu ini dapat mengakibatkan reaksi alergi dan/atau penyakit saluran pernapasan pada pengguna atau orang yang berada di dekatnya.

Beberapa debu tertentu seperti debu kayu pohon quercus atau pohon fagus silvatica dianggap dapat mengakibatkan penyakit kanker, terutama dalam campuran dengan bahan-

bahan tambahan untuk pengolahan kayu (kromat, obat pengawet kayu). Bahan-bahan yang mengandung asbestos hanya boleh dikerjakan oleh orang-orang yang ahli.

- Perhatikanlah supaya ada pertukaran udara yang baik di tempat kerja.
- Kami anjurkan Anda memakai masker anti debu dengan filter kelas P2.

Taatilah peraturan-peraturan untuk bahan-bahan yang dikerjakan yang berlaku di negara Anda.

- **Hindari debu yang banyak terkumpul di tempat kerja.** Debu dapat tersulut dengan mudah.

Penggunaan

Pengoperasian

Memasang baterai

Pasang baterai yang telah diisi **(7)** ke dalam kaki perkakas listrik dari depan hingga baterai terkunci dengan aman.

Menyalakan/mematikan perkakas listrik

Untuk **mulai menyalakan** perkakas listrik, geser tombol on/off **(5)** ke depan.

Untuk **mengunci** tombol on/off **(5)**, dorong tombol on/off **(5)** ke depan hingga mengunci.

Untuk **mematikan** perkakas listrik, lepaskan tombol on/off **(5)** atau jika tombol terkunci, tekan tombol on/off **(5)** ke belakang secara singkat kemudian lepaskan tombol.

- **Periksa alat gerinda sebelum digunakan. Alat gerinda harus dipasang dengan benar dan dapat berputar dengan bebas. Lakukan uji coba minimal selama satu menit tanpa beban. Jangan menggunakan alat gerinda yang rusak, tidak bulat atau bergetar.** Alat gerinda yang rusak dapat pecah dan menyebabkan cedera.

Kickback stop (pengaman terhadap bantingan)



Jika terjadi kickback secara tiba-tiba pada perkakas listrik, misalnya macet selama pemotongan, suplai daya listrik ke mesin akan berhenti secara elektronik. Display kickback stop **(26)** akan menyala. Saat kickback stop diaktifkan, display status **(30)** berkedip merah.

Untuk **mengoperasikan kembali** perkakas listrik, atur tombol on/off **(5)** ke posisi off, kemudian nyalakan kembali perkakas listrik.

Pelindung terhadap start ulang

Pelindung terhadap start ulang mencegah perkakas listrik menyala kembali secara tidak terkendali setelah suplai daya listrik terputus.

Saat pelindung terhadap start ulang diaktifkan, display status **(30)** berkedip merah.

Untuk **mengoperasikan kembali** perkakas listrik, atur tombol on/off **(5)** ke posisi off, kemudian nyalakan kembali perkakas listrik.

Penonaktifan akibat benturan

Perkakas listrik akan dimatikan dengan fitur penonaktifan akibat benturan yang terintegrasi ketika perkakas terjatuh. Display status **(30)** akan berkedip merah.

Untuk **mengoperasikan kembali** perkakas listrik, atur tombol on/off **(5)** ke posisi off, kemudian nyalakan kembali perkakas listrik.

User Interface (lihat gambar A)

User Interface **(4)** digunakan untuk memilih kecepatan putaran di awal dan menampilkan status perkakas listrik.

Pemilihan awal kecepatan putaran (GWS 18V-15 SC)

Pada pengaturan pabrik, 3 tingkat kecepatan putaran telah diatur sebelumnya. Hingga 6 tingkat kecepatan putaran dapat diprogram melalui aplikasi khusus (Bosch Toolbox App).

Jika jumlah tingkat kecepatan putaran diubah, nilai tingkat tunggal disesuaikan secara default. Pada situasi tersebut, display mode/tingkat kecepatan putaran **(28)** menyala putih. Jika nilai kecepatan putaran diprogram secara individu, display mode/tingkat kecepatan putaran **(28)** akan menyala biru pada tingkat kecepatan ini (yakni tidak sesuai dengan pengaturan dasar). Penyesuaian individu tingkat kecepatan putaran dapat dilakukan setiap 200 min^{-1} dalam interval. Perhatikan kesesuaian tingkat yang naik ($2 \geq 1 / 3 \geq 2$ dll.).

Tabel berikut ini menunjukkan kecepatan putaran yang diatur sebelumnya (pengaturan dasar) untuk setiap jumlah tingkat yang diprogram.

GWS 18V-15 SC	Pengaturan dasar kecepatan putaran pada tingkat					
	1	2	3	4	5	6
	[min^{-1}]	[min^{-1}]	[min^{-1}]	[min^{-1}]	[min^{-1}]	[min^{-1}]
Jumlah tingkat kecepatan putaran						
1	3400	–	–	–	–	–
2	3400	9800	–	–	–	–
3	3400	6600	9800	–	–	–
4	3400	5600	7600	9800	–	–
5	3400	5000	6600	8200	9800	–
6	3400	4600	6000	7200	8600	9800

Nilai tingkat kecepatan putaran yang tertera bergantung pada baterai yang digunakan, status daya baterai serta suhu pengoperasian perangkat.

Dengan tombol pemilihan awal kecepatan putaran **(27)**, kecepatan putaran yang diperlukan juga dapat dipilih sebelumnya saat mengoperasikan perkakas listrik. Informasi pada tabel di bawah adalah nilai yang direkomendasikan untuk pengaturan pabrik dengan 3 tingkat kecepatan putaran yang telah diatur sebelumnya.

Bahan	Penggunaan	Alat sisipan	Tingkat pilihan kecepatan putaran	GWS 18V-15 SC [min^{-1}]
Logam	Menyikat, menghilangkan karat	Sikat kawat	1	3400
Baja tahan karat	Mengampelas	Cakram serat (fiber disc)	2	6600
Logam	Mengikis	Mata gerinda	3	maks
Logam	Memotong	Mata gerinda	3	maks
Batu	Memotong	Cakram potong intan dan unit pemandu (pemotongan batu hanya diperbolehkan dengan unit pemandu)	3	maks

► **Ukuran kecepatan aksesorinya harus sama dengan kecepatan maksimum yang tertera pada**

perkakas listrik. Aksesoris yang beroperasi lebih cepat dari ukuran kecepatan yang tertera dapat rusak dan terlepas.

Display status

Indikator level pengisian daya baterai (User Interface) (25)	Arti/penyebab	Solusi
hijau	Baterai telah terisi daya	–
kuning	Baterai hampir kosong	Segera ganti atau isi daya baterai
merah	Baterai kosong	Ganti atau isi daya baterai

Display suhu (31)	Arti/penyebab	Solusi
kuning	Suhu kritis tercapai (mesin, elektronik, baterai)	Operasikan perkakas listrik pada posisi idle dan dinginkan
merah	Perkakas listrik terlalu panas dan mati	Dinginkan perkakas listrik

Display status perkakas listrik (30)	Arti/penyebab	Solusi
hijau	Status OK	–
kuning	Suhu kritis tercapai atau baterai hampir kosong	Operasikan perkakas listrik pada posisi idle dan dinginkan atau segera ganti atau isi daya baterai
menyala merah	Perkakas listrik terlalu panas atau baterai kosong	Biarkan perkakas listrik menjadi dingin atau ganti atau isi daya baterai
berkedip merah	Fitur kickback stop, pelindung terhadap start ulang atau penonaktifan akibat benturan telah terpicu	Matikan dan nyalakan kembali perkakas listrik
berkedip biru	Perkakas listrik terhubung dengan perangkat seluler atau pengaturan dikirim	–

Fungsi konektivitas

Berkaitan dengan modul *Bluetooth*® Low Energy **GCY 42**, fungsi konektivitas berikut tersedia untuk perkakas listrik:

- Pendaftaran dan personalisasi
- Cek status, tampilan pesan peringatan
- Informasi umum dan pengaturan
- Perawatan

Untuk informasi mengenai modul *Bluetooth*® Low Energy **GCY 42**, baca panduan pengoperasian terkait.

Sambungan perkakas listrik dengan aplikasi harus dipastikan dengan menekan tombol pemilihan awal kecepatan putaran (27) pada User Interface (4). Aplikasi akan meminta hal ini saat menyambungkan.

Petunjuk pengoperasian

- ▶ **Perkakas listrik dengan modul *Bluetooth*® Low Energy GCY 42 yang terpasang dilengkapi dengan antarmuka nirkabel. Perhatikan batasan pengoperasian lokal, misalnya dalam pesawat terbang atau di rumah sakit.**
- ▶ **Area yang tidak mengizinkan penggunaan teknologi nirkabel *Bluetooth*®, modul *Bluetooth*® Low Energy GCY 42 dan baterai kancing harus dilepas.**
- ▶ **Berhati-hatilah saat membuat aluran instalasi pada dinding struktural, lihat bab "Petunjuk mengenai struktur".**

- ▶ **Tahan benda kerja, jika benda tetap goyah karena menahan bebannya sendiri.**
- ▶ **Jangan membebankan perkakas listrik terlalu berat sehingga perkakas berhenti.**
- ▶ **Setelah pembebanan yang berat, biarkan perkakas listrik beroperasi tanpa beban selama beberapa menit untuk mendinginkan aksesoris yang digunakan.**
- ▶ **Jangan menggunakan perkakas listrik dengan penopang untuk mesin gerinda potong.**
- ▶ **Jangan memegang mata gerinda dan mata potong sebelum alat-alat tersebut menjadi dingin.** Piringan-piringan ini menjadi sangat panas selama penggunaannya.

Jika perkakas listrik bermuatan elektrostatis, elektronik yang terpasang akan mematikan perkakas listrik. Tekan kembali tombol on/off (5) untuk mengoperasikan kembali perkakas listrik.

Mengikis

- ▶ **Jangan menggunakan mata potong untuk mengikis.**

Hasil kerja terbaik saat mengikis dapat diperoleh dengan sudut kerja antara 30° hingga 40°. Gerakkan perkakas listrik dengan tekanan yang sedang maju-mundur. Dengan demikian, benda kerja tidak terlalu panas, warna permukaan benda kerja tidak berubah, dan penampang menjadi lebih halus.

Flap disc abrasif

Permukaan dan profil juga dapat dikerjakan menggunakan flap disc abrasif (aksesori).

Flap disc abrasif memiliki masa pakai yang lebih lama daripada kertas ampelas biasa, nilai kebingangan dan suhu penggerindaan yang lebih rendah.

Memotong logam

► Saat memotong dengan bahan yang kasar, selalu pasang kap pelindung untuk memotong (15).

Selama memotong, dorong perkakas dengan tekanan sedang dan yang disesuaikan dengan bahan yang dikerjakan. Jangan menekan, memiringkan atau mengayun-ayunkan cakram potong.

Jangan menghentikan gerak cakram potong yang belum berhenti berputar dengan cara menekan sisi sampingnya.

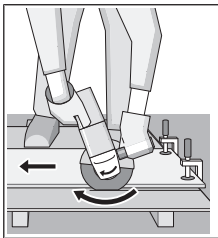

Arah pemotongan harus selalu berlawanan dengan arah gerak dari alat kerja. Jika tidak, terdapat risiko adanya tekanan pada perkakas listrik yang **tak terkendali** dari jalur pemotongan.

Selama memotong profil atau tabung persegi, gunakan penampang

terkecil untuk hasil pemotongan terbaik.

Memotong batu-batuan

► Perhatikan penghisapan debu yang memadai saat memotong bahan batu-batuan.

► Pakailah masker debu.

► Perkakas listrik ini hanya boleh digunakan untuk pemotongan/pengikisan kering.

Untuk memotong batu-batuan, sebaiknya gunakan cakram potong intan.

Selama memotong bahan-bahan yang sangat keras, misalnya beton dengan kadar kerikil yang tinggi, mata potong intan dapat menjadi terlalu panas sehingga dapat menjadi rusak. Hal tersebut ditunjukkan dengan adanya lingkaran bunga api yang berputar bersama dengan cakram potong intan.

Dalam hal ini hentikan pekerjaan memotong dan biarkan cakram potong intan berputar sebentar tanpa beban pada kecepatan putaran maksimal untuk mendinginkannya.

Jika pekerjaan menghabiskan waktu lama dan terdapat lingkaran bunga api, hal ini menandakan cakram potong intan telah menjadi tumpul. Cakram dapat diasah dengan cara memotong sedikit-sedikit pada bahan pengikisan, misalnya batu pasir kapur.

Petunjuk mengenai struktur

Membuat aluran instalasi pada dinding yang berstruktur harus tunduk pada peraturan-peraturan norma DIN 1053 Bagian 1 atau peraturan-peraturan yang berlaku di negara terkait. Peraturan tersebut harus ditaati. Sebelum memulai pekerjaan, mintalah saran dari ahli struktur, arsitek atau pengawas bangunan.

Petunjuk mengenai penanganan baterai yang optimal

Lindungilah baterai dari kelembapan dan air.

Simpan baterai hanya pada rentang suhu antara -20°C hingga 50°C . Jangan meletakkan baterai di dalam mobil, misalnya pada musim panas.

Bersihkan lubang ventilasi baterai dengan kuas yang lembut, bersih dan kering secara berkala.

Waktu pengoperasian yang berkurang secara signifikan setelah pengisian daya menunjukkan bahwa baterai telah aus dan perlu diganti.

Perhatikan petunjuk mengenai pembuangan baterai.

Perawatan dan servis

Perawatan dan pembersihan

► **Sebelum melakukan semua pekerjaan pada perkakas listrik (misalnya merawat, mengganti alat kerja, dsb.) serta selama transpor dan penyimpanan, keluarkanlah baterai dari perkakas listrik.** Terdapat risiko cedera apabila tombol untuk menghidupkan dan mematikan dioperasikan tanpa sengaja.

► **Perkakas listrik dan lubang ventilasi harus selalu dibersihkan agar perkakas dapat digunakan dengan baik dan aman.**

Simpan dan tangani aksesori secara cermat.

Layanan pelanggan dan konsultasi penggunaan

Layanan pelanggan Bosch menjawab semua pertanyaan Anda tentang reparasi dan perawatan serta tentang suku cadang produk ini. Gambaran teknis (exploded view) dan informasi mengenai suku cadang dapat ditemukan di:

www.bosch-pt.com

Tim konsultasi penggunaan Bosch akan membantu Anda menjawab pertanyaan seputar produk kami beserta aksesorinya.

Jika Anda hendak menanyakan sesuatu atau memesan suku cadang, selalu sebutkan nomor model yang terdiri dari 10 angka dan tercantum pada label tipe produk.

Indonesia

PT Robert Bosch

Palma Tower 10th Floor

Jalan RA Kartini II-S Kaveling 6

Pondok Pinang, Kebayoran Lama

Jakarta Selatan 12310

Tel.: (021) 3005 5800

Fax: (021) 3005 5801

E-Mail: boschpowertools@id.bosch.com

www.bosch-pt.co.id

Alamat layanan lainnya dapat ditemukan di:

www.bosch-pt.com/serviceaddresses

Transpor

Pada baterai-baterai li-ion yang digunakan diterapkan persyaratan terkait peraturan-peraturan tentang bahan-

bahan yang berbahaya. Baterai-baterai dapat diangkut oleh penggunanya tanpa pembatasan lebih lanjut di jalan. Pada pengiriman oleh pihak ketiga (misalnya transportasi udara atau perusahaan ekspedisi) harus ditaati syarat-syarat terkait kemasan dan pemberian tanda. Dalam hal ini, diperlukan konsultasi dengan ahli bahan-bahan berbahaya saat mengatur barang pengiriman.

Kirimkan baterai hanya jika housing-nya tidak rusak. Tutup bagian-bagian yang terbuka dan kemas baterai agar tidak bergerak-gerak di dalam kemasan. Taatilah peraturan-peraturan nasional lainnya yang mungkin lebih rinci yang berlaku di negara Anda.

Cara membuang



Perkakas listrik, baterai, aksesoris dan kemasan harus didaur ulang dengan cara yang ramah lingkungan.



Jangan membuang perkakas listrik, aki/baterai ke dalam sampah rumah tangga!

Baterai:

Li-ion:

Perhatikanlah petunjuk-petunjuk dalam bab Transpor (lihat „Transpor“, Halaman 71).

- ▶ **Không để trẻ em hay người đến xem đứng gần khi vận hành dụng cụ điện cầm tay.** Sự phân tâm có thể gây ra sự mất điều khiển.

An toàn về điện

- ▶ **Phích cắm của dụng cụ điện cầm tay phải thích hợp với ổ cắm. Không bao giờ được cải biến lại phích cắm dưới mọi hình thức. Không được sử dụng phích tiếp hợp nối tiếp đất (dây mát).** Phích cắm nguyên bản và ổ cắm đúng loại sẽ làm giảm nguy cơ bị điện giật.
- ▶ **Tránh không để thân thể tiếp xúc với đất hay các vật có bề mặt tiếp đất như đường ống, lò sưởi, hàng rào và tủ lạnh.** Có nhiều nguy cơ bị điện giật hơn nếu cơ thể bạn bị tiếp hay nối đất.
- ▶ **Không được để dụng cụ điện cầm tay ngoài mưa hay ở tình trạng ẩm ướt.** Nước vào máy sẽ làm tăng nguy cơ bị điện giật.
- ▶ **Không được lạm dụng dây dẫn điện. Không bao giờ được nắm dây dẫn để xách, kéo hay rút phích cắm dụng cụ điện cầm tay. Không để dây gần nơi có nhiệt độ cao, dầu nhớt, vật nhọn bén và bộ phận chuyển động.** Làm hỏng hay cuộn rối dây dẫn làm tăng nguy cơ bị điện giật.
- ▶ **Khi sử dụng dụng cụ điện cầm tay ngoài trời, dùng dây nối thích hợp cho việc sử dụng ngoài trời.** Sử dụng dây nối thích hợp cho việc sử dụng ngoài trời làm giảm nguy cơ bị điện giật.
- ▶ **Nếu việc sử dụng dụng cụ điện cầm tay ở nơi ẩm ướt là không thể tránh được, dùng thiết bị ngắt mạch tự động (RCD) bảo vệ nguồn.** Sử dụng thiết bị ngắt mạch tự động RCD làm giảm nguy cơ bị điện giật.

An toàn cá nhân

- ▶ **Hãy tỉnh táo, biết rõ mình đang làm gì và hãy sử dụng ý thức khi vận hành dụng cụ điện cầm tay. Không sử dụng dụng cụ điện cầm tay khi đang mệt mỏi hay đang bị tác động do chất gây nghiện, rượu hay dược phẩm gây ra.** Một thoáng mất tập trung khi đang vận hành dụng cụ điện cầm tay có thể gây thương tích nghiêm trọng cho bản thân.
- ▶ **Sử dụng trang bị bảo hộ cá nhân. Luôn luôn đeo kính bảo vệ mắt.** Trang bị bảo hộ như khẩu trang, giày chống trượt, nón bảo hộ, hay dụng cụ bảo vệ tai khi được sử dụng đúng nơi đúng chỗ sẽ làm giảm nguy cơ thương tật cho bản thân.
- ▶ **Phòng tránh máy khởi động bất ngờ. Bảo đảm công tắc máy ở vị trí tắt trước khi cắm vào nguồn điện và/hay lắp pin vào, khi nhấn máy lên hay khi mang xách máy.** Ngáng ngón tay vào công tắc máy để xách hay kích hoạt dụng cụ điện cầm tay khi công tắc ở vị trí mở dễ dẫn đến tai nạn.
- ▶ **Lấy mọi chìa hay khóa điều chỉnh ra trước khi mở điện dụng cụ điện cầm tay.** Khóa hay

Tiếng Việt

Hướng dẫn an toàn

Cảnh báo Tổng quát Cách sử dụng An toàn Dụng cụ điện Cầm tay

⚠ CẢNH BÁO Đọc kỹ mọi cảnh báo an toàn và hướng dẫn. Không tuân thủ mọi cảnh báo và hướng dẫn được liệt kê dưới đây có thể bị điện giật, gây cháy và / hay bị thương tật nghiêm trọng.

Hãy giữ tất cả tài liệu về cảnh báo và hướng dẫn để tham khảo về sau.

Thuật ngữ "dụng cụ điện cầm tay" trong phần cảnh báo là để cập đến sự sử dụng dụng cụ điện cầm tay của bạn, loại sử dụng điện nguồn (có dây cắm điện) hay vận hành bằng pin (không dây cầm điện).

Khu vực làm việc an toàn

- ▶ **Giữ nơi làm việc sạch và đủ ánh sáng.** Nơi làm việc bừa bộn và tối tăm dễ gây ra tai nạn.
- ▶ **Không vận hành dụng cụ điện cầm tay trong môi trường dễ gây nổ, chẳng hạn như nơi có chất lỏng dễ cháy, khí đốt hay rác.** Dụng cụ điện cầm tay tạo ra các tia lửa nên có thể làm rác bén cháy hay bốc khói.

chìa còn gắn dính vào bộ phận quay của dụng cụ điện cầm tay có thể gây thương tích cho bản thân.

- ▶ **Không rướn người. Luôn luôn giữ tư thế đứng thích hợp và thăng bằng.** Điều này tạo cho việc điều khiển dụng cụ điện cầm tay tốt hơn trong mọi tình huống bất ngờ.
- ▶ **Trang phục thích hợp. Không mặc quần áo rộng lủng thụng hay mang trang sức. Giữ tóc, quần áo và găng tay xa khỏi các bộ phận chuyển động.** Quần áo rộng lủng thụng, đồ trang sức hay tóc dài có thể bị cuốn vào các bộ phận chuyển động.
- ▶ **Nếu có các thiết bị đi kèm để nối máy hút bụi và các phụ kiện khác, bảo đảm các thiết bị này được nối và sử dụng tốt.** Việc sử dụng các thiết bị gom hút bụi có thể làm giảm các độc hại liên quan đến bụi gây ra.

Sử dụng và bảo dưỡng dụng cụ điện cầm tay

- ▶ **Không được ép máy. Sử dụng dụng cụ điện cầm tay đúng loại theo đúng ứng dụng của bạn.** Dụng cụ điện cầm tay đúng chức năng sẽ làm việc tốt và an toàn hơn theo đúng tiến độ mà máy được thiết kế.
- ▶ **Không sử dụng dụng cụ điện cầm tay nếu như công tắc không tắt và mở được.** Bất kỳ dụng cụ điện cầm tay nào mà không thể điều khiển được bằng công tắc là nguy hiểm và phải được sửa chữa.
- ▶ **Rút phích cắm ra khỏi nguồn điện và/hay pin ra khỏi dụng cụ điện cầm tay trước khi tiến hành bất kỳ điều chỉnh nào, thay phụ kiện, hay cất dụng cụ điện cầm tay.** Các biện pháp ngăn ngừa như vậy làm giảm nguy cơ dụng cụ điện cầm tay khởi động bất ngờ.
- ▶ **Cất giữ dụng cụ điện cầm tay không dùng tới nơi trẻ em không lấy được và không cho người chưa từng biết dụng cụ điện cầm tay hay các hướng dẫn này sử dụng dụng cụ điện cầm tay.** Dụng cụ điện cầm tay nguy hiểm khi ở trong tay người chưa được chỉ cách sử dụng.
- ▶ **Bảo quản dụng cụ điện cầm tay. Kiểm tra xem các bộ phận chuyển động có bị sai lệch hay kẹt, các bộ phận bị rạn nứt và các tình trạng khác có thể ảnh hưởng đến sự vận hành của máy. Nếu bị hư hỏng, phải sửa chữa máy trước khi sử dụng.** Nhiều tai nạn xảy ra do bảo quản dụng cụ điện cầm tay tồi.
- ▶ **Giữ các dụng cụ cất bên và sạch.** Bảo quản đúng cách các dụng cụ cất có cạnh cắt bên làm giảm khả năng bị kẹt và dễ điều khiển hơn.
- ▶ **Sử dụng dụng cụ điện cầm tay, phụ kiện, đầu cài v. v., đúng theo các chỉ dẫn này, hãy lưu ý đến điều kiện làm việc và công việc phải thực hiện.** Sự sử dụng dụng cụ điện cầm tay khác

với mục đích thiết kế có thể tạo nên tình huống nguy hiểm.

Sử dụng và bảo quản dụng cụ dùng pin

- ▶ **Chỉ được sạc pin lại với bộ nạp điện do nhà sản xuất chỉ định.** Bộ nạp điện thích hợp cho một loại pin có thể gây nguy cơ cháy khi sử dụng cho một loại pin khác.
- ▶ **Chỉ sử dụng dụng cụ điện cầm tay với loại pin được thiết kế đặt biệt dành riêng cho máy.** Sử dụng bất cứ loại pin khác có thể dẫn đến thương tật hay cháy.
- ▶ **Khi không sử dụng pin, để cách xa các vật bằng kim loại như kẹp giấy, tiền xu, chìa khoá, đinh, ốc vít hay các đồ vật kim loại nhỏ khác, thứ có thể tạo sự nối tiếp từ một đầu cực với một đầu cực khác.** Sự chập mạch của các đầu cực với nhau có thể gây bỏng hay cháy.
- ▶ **Bảo quản ở tình trạng tối, dung dịch từ pin có thể tứa ra; tránh tiếp xúc. Nếu vô tình chạm phải, hãy xối nước để rửa. Nếu dung dịch vào mắt, cần thêm sự hỗ trợ của y tế.** Dung dịch tiết ra từ pin có thể gây ngứa hay bỏng.

Bảo dưỡng

- ▶ **Đưa dụng cụ điện cầm tay của bạn đến thợ chuyên môn để bảo dưỡng, chỉ sử dụng phụ tùng đúng chủng loại để thay.** Điều này sẽ đảm bảo sự an toàn của máy được giữ nguyên.

Cảnh Báo An Toàn cho Máy Mài Hình Góc

Các cảnh báo An toàn chung cho các thao tác Mài, Phun cát, Chải bóng bằng Kim loại hoặc Cát bằng Ráp

- ▶ **Dụng cụ điện cầm tay này có chức năng như một máy mài, máy phun cát, bàn chải đánh bóng kim loại hoặc dụng cụ cắt.** Hãy đọc toàn bộ các cảnh báo an toàn, hướng dẫn, hình ảnh và thông số kỹ thuật được cung cấp cho dụng cụ điện cầm tay này. Không tuân thủ mọi hướng dẫn được liệt kê dưới đây có thể bị điện giật, gây cháy và/hay bị thương tật nghiêm trọng.
- ▶ **Không nên thực hiện các thao tác như đánh bóng bằng dụng cụ điện cầm tay này.** Các thao tác không được thiết kế cho dụng cụ điện cầm tay này có thể gây nguy hiểm hoặc gây tổn thương cho con người.
- ▶ **Không được sử dụng các phụ kiện không được thiết kế riêng và khuyến dùng bởi nhà sản xuất dụng cụ.** Bởi vì phụ kiện có thể gắn được với dụng cụ điện cầm tay của bạn, nhưng nó không đảm bảo hoạt động an toàn.
- ▶ **Tốc độ định mức của phụ kiện tối thiểu phải bằng tốc độ tối đa được ghi trên dụng cụ điện cầm tay.** Các phụ kiện chạy nhanh hơn

tốc độ định mức của chúng có thể bị vỡ và văng ra.

- ▶ **Đường kính ngoài và độ dày của phụ kiện phải nằm trong định mức công suất của dụng cụ điện cầm tay của bạn.** Không thể bảo vệ hoặc kiểm soát phù hợp các phụ kiện sai kích cỡ.
- ▶ **Lắp ghép ta lông của các phụ kiện phải khớp với đầu ren trục chính của máy mài. Đối với các phụ kiện được lắp ghép bằng các bích, lỗ tâm của phụ kiện phải khít với đường kính định vị của bích.** Các phụ kiện không khớp với các phụ kiện cứng ghép nối của dụng cụ điện cầm tay sẽ làm mất cân bằng, rung lắc quá mức và có thể làm mất kiểm soát.
- ▶ **Không được sử dụng phụ kiện bị hư hỏng. Trước mỗi lần sử dụng, cần kiểm tra kỹ các vết nứt và rạn của đĩa mài, các vết rạn nứt, mòn hoặc mài mòn quá mức của tấm đệm, các đầu kim loại bị lỏng hoặc bị nứt của bản chải kim loại. Nếu làm rơi dụng cụ điện cầm tay hoặc phụ kiện, cần kiểm tra hư hỏng hoặc thay thế bằng phụ kiện không bị hư hỏng. Sau khi kiểm tra và thay thế phụ kiện, bạn và người xung quanh đứng phải tránh hướng lưỡi bào của các phụ kiện xoay và khởi động dụng cụ điện ở tốc độ không tải tối đa trong vòng một phút.** Các phụ kiện bị hư hỏng thường bị vỡ rời trong quá trình chạy thử này.
- ▶ **Mặc thiết bị bảo hộ cá nhân. Tùy thuộc vào từng công việc, hãy sử dụng mặt nạ, kính bảo vệ hoặc kính an toàn. Nếu có, hãy đeo mặt nạ chống bụi, dụng cụ bảo vệ tai, găng tay và tạp dề lao động có thể ngăn chặn mài nhỏ hoặc các mảnh vụn của phôi.** Dụng cụ bảo vệ mắt phải có khả năng ngăn chặn mảnh vỡ bắn ra do các thao tác khác nhau sinh ra. Mặt nạ chống bụi hoặc mặt nạ chống độc phải có khả năng lọc các tạp chất do thao tác của bạn sinh ra. Việc tiếp xúc lâu với tiếng ồn quá cao có thể làm giảm thính giác.
- ▶ **Hãy cách ly người xung quanh tránh xa khu vực làm việc một khoảng cách an toàn. Bất kỳ ai đi vào khu vực làm việc phải mặc thiết bị bảo hộ cá nhân.** Các mảnh vỡ của phôi hoặc của phụ kiện bị vỡ có thể văng ra ngoài khỏi khu vực làm việc và có thể gây tổn thương.
- ▶ **Chỉ cắm dụng cụ điện tại các bề mặt cầm nắm có cách điện, khi thực hiện một thao tác tại vị trí mà phụ kiện cắt có thể tiếp xúc với dây điện ngầm.** Phụ kiện cắt tiếp xúc với dây có điện có thể làm cho các phần kim loại hở của dụng cụ điện cầm tay có điện và có thể gây ra điện giật cho người vận hành.
- ▶ **Tuyệt đối không để dụng cụ điện cầm tay xuống đất cho tới khi phần quay của thiết bị đã dừng hẳn.** Phần phụ kiện quay có thể ngọam

bề mặt và kéo dụng cụ điện cầm tay khỏi tầm kiểm soát.

- ▶ **Không được vận hành dụng cụ điện cầm tay trong khi đang đeo nơ trên người.** Việc vô tình tiếp xúc với phần phụ kiện quay có thể ngọam quần áo của bạn, kéo phụ kiện về phía của bạn.
- ▶ **Thường xuyên vệ sinh các lỗ thông khí của dụng cụ điện cầm tay.** Quạt của mô tơ sẽ hút bụi bẩn vào trong vỏ ngoài và việc tích tụ quá mức mặt kim loại có thể gây ra các rủi ro điện giật.
- ▶ **Không được vận hành dụng cụ điện cầm tay gần các vật liệu dễ cháy.** Các tia lửa có thể đốt cháy các vật liệu đó.
- ▶ **Không được sử dụng các phụ kiện cần sử dụng các dung dịch làm nguội.** Việc sử dụng nước hoặc các dung dịch làm nguội khác có thể gây ra điện giật.

Lực phản hồi và các Cảnh báo Liên quan

Lực phản hồi là một lực tác động đột ngột lên đĩa quay, tấm đệm, bản chải hoặc bất kỳ phụ kiện nào khác bị ép hoặc mài mòn. Việc ép hoặc mài mòn làm cho phần phụ kiện quay dừng gấp sau đó gây ra tác động mạnh vào thiết bị điện cầm tay không kiểm soát được theo hướng ngược với hướng quay của phụ kiện tại điểm liên kết.

Ví dụ, nếu đĩa mài bị mài mòn hoặc ép bởi phôi gia công, mép của đĩa mài tiếp xúc với điểm ép có thể tạo rãnh bề mặt của vật liệu làm cho đĩa mài nhô ra hoặc va đập. Đĩa mài có thể nhảy về phía hoặc nhảy ra ngoài từ phía người vận hành, tùy thuộc vào hướng di chuyển của đĩa mài tại điểm ép. Các đĩa mài cũng có thể bị vỡ trong các trường hợp này. Lực phản hồi là do việc sử dụng sai và/hoặc quy trình hoặc điều kiện vận hành sai dụng cụ điện cầm tay và có thể phòng tránh bằng cách áp dụng các biện pháp phòng ngừa phù hợp được nêu dưới đây.

- ▶ **Giữ chặt dụng cụ điện cầm tay và giữ cho cơ thể và tay của bạn chắc chắn cho phép bạn chịu được các lực phản hồi. Luôn sử dụng tay cầm phụ, nếu có, để kiểm soát tối đa lực phản hồi hoặc lực mômen xoắn trong khi khởi động.** Người vận hành có thể kiểm soát được các lực mômen xoắn hoặc lực phản hồi nếu áp dụng các biện pháp phòng ngừa phù hợp.
- ▶ **Tuyệt đối không để tay gần phần phụ kiện quay.** Phụ kiện có thể tác động lại tay của bạn.
- ▶ **Không được đứng tại nơi dụng cụ điện cầm tay di chuyển nếu xảy ra lực phản hồi.** Lực phản hồi sẽ đẩy dụng cụ theo hướng ngược với hướng di chuyển của đĩa mài tại điểm mài mòn.
- ▶ **Sử dụng tấm bảo vệ đặc biệt khi làm việc tại các góc, cạnh sắc v.v.v. Tránh làm nảy và mài mòn phụ kiện.** Các góc, cạnh sắc hoặc

việc này lên có thể mài mòn phụ kiện quay và dẫn đến mất kiểm soát hoặc đẩy ngược lại.

- ▶ **Không được lắp thêm lưới cửa gỗ dạng lưới cửa xích hoặc lưới cửa có răng.** Các lưới như vậy có thể tạo lực phản hồi thường xuyên và làm mất kiểm soát.

Các Cảnh báo An toàn dành riêng cho các thao tác Mài và Cắt

- ▶ **Chỉ sử dụng các loại đĩa được chỉ định cho dụng cụ điện cầm tay của bạn và lá chắn bảo vệ riêng được thiết kế cho đĩa cắt đã chọn.** Các loại đĩa không được thiết kế cho dụng cụ điện cầm tay này có thể không được bảo vệ phù hợp và không an toàn.
- ▶ **Bề mặt mài của các đĩa mài làm giảm trực tâm phải được lắp phía dưới phần phẳng của vành chắn bảo vệ.** Đĩa lắp ghép không đúng cách chia ra khỏi bề mặt của vành chắn bảo vệ có thể không được bảo vệ phù hợp.
- ▶ **Vành chắn bảo vệ phải được gắn cố định vào dụng cụ điện cầm tay và đảm bảo sự an toàn tối đa, sao cho phần đĩa hở ra hướng về phía người vận hành ít nhất.** Vành bảo vệ giúp bảo vệ người vận hành tránh các mảnh vỡ đĩa mài, tiếp xúc do vô tình với đĩa mài hoặc các tia lửa có thể gây cháy quần áo.
- ▶ **Phải sử dụng các đĩa mài được chỉ định riêng cho từng công việc. Ví dụ: không được mài bằng cạnh của đĩa cắt.** Các đĩa cắt bằng nhôm chỉ được sử dụng cho mài mép, các lực biên tác dụng vào các đĩa cắt này có thể làm chúng bị vỡ.
- ▶ **Luôn sử dụng các bích đệm đĩa không bị hư hỏng đúng kích cỡ và hình dạng cho đĩa đã chọn của bạn.** Các bích đệm đĩa phù hợp đỡ đĩa mài cho phép làm giảm khả năng vỡ đĩa. Các bích đệm cho các đĩa cắt có thể khác với các bích đệm đĩa mài.
- ▶ **Không được sử dụng các đĩa đã mài mòn từ các dụng cụ điện lớn hơn.** Đĩa dành riêng cho dụng cụ điện cầm tay lớn hơn không phù hợp cho tốc độ cao hơn của dụng cụ điện nhỏ hơn và có thể vỡ.

Các Cảnh báo An toàn Bổ sung dành riêng cho các thao tác Cắt

- ▶ **Không được làm kẹt đĩa cắt hoặc tỳ đè quá lực. Không được cố gắng cắt sâu quá mức.** Việc tạo ứng suất quá mức lên đĩa làm tăng tải và dễ gây ra xoắn hoặc kẹt đĩa trong khi cắt và có thể tạo lực phản hồi hoặc làm vỡ đĩa.
- ▶ **Không được đứng song song và phía sau đĩa quay.** Khi đĩa, ở vị trí vận hành, đang di chuyển theo hướng cơ thể bạn, lực phản hồi có thể đẩy đĩa quay và đĩa quay và dụng cụ trực tiếp về phía bạn.
- ▶ **Khi đĩa bị kẹt hoặc khi dừng cắt vì lý do nào đó, hãy tắt nguồn dụng cụ điện cầm tay và giữ cố định thiết bị điện tới khi đĩa đã dừng**

quay hẳn. Tuyệt đối không cố gắng tháo đĩa cắt ra trong khi đĩa vẫn đang quay nếu không lực phản hồi có thể xảy ra. Kiểm tra và có biện pháp khắc phục để loại bỏ nguyên nhân kẹt đĩa.

- ▶ **Không được khởi động lại thao tác cắt khi bị kẹt trong phôi. Để đĩa quay đạt tốc độ cực đại và cẩn thận khởi động lại đường cắt.** Đĩa có thể bị kẹt, nảy lên hoặc tác động trở lại nếu khởi động lại dụng cụ điện kẹt trong phôi.
- ▶ **Sử dụng các tấm đỡ hoặc phôi quá kích cỡ để giảm thiểu nguy cơ ép đĩa và lực phản hồi.** Các phôi lớn thường vông xuống dưới trọng lượng riêng của chúng. Cần phải đặt các tấm đỡ phía dưới phôi gần đường cắt và gần cạnh của phôi về cả hai phía của đĩa cắt.
- ▶ **Sử dụng biện pháp an toàn khác khi cắt rãnh vào các vách hiện có hoặc các khu vực chân tường.** Đĩa cắt nhô lên có thể cắt đứt các đường ống khí hoặc nước, dây điện hoặc các vật dụng có thể gây ra lực phản hồi.

Các Cảnh báo An toàn Bổ sung dành riêng cho các thao tác Mài

- ▶ **Không được sử dụng đĩa mài quá kích cỡ. Tuân thủ các khuyến nghị của nhà sản xuất khi chọn đĩa mài.** Đĩa mài lớn hơn vượt quá kích cỡ tấm đệm mài gây ra nguy cơ xé rách và có thể gây mài mòn, rách đĩa mài hoặc lực phản hồi.

Các Cảnh báo An toàn Bổ sung dành riêng cho các thao tác Chải bóng

- ▶ **Cần lưu ý rằng các sợi tổng hợp dây điện bị mắc vào bàn chải ngay cả khi vận hành bình thường. Không được kéo quá căng dây điện bằng cách đè quá tải vào bàn chải.** Các sợi tổng hợp dây điện có thể dễ dàng thân nhập vào quần áo mỏng và/hoặc da.
- ▶ **Nếu cần phải sử dụng vành chắn bảo vệ để chải bóng, không được để đĩa đệm kim loại hoặc bàn chải dính vào vành bảo vệ.** Đĩa đệm kim loại hoặc bàn chải có thể giãn ra do tải làm việc và các lực ly tâm.

Các cảnh báo phụ thêm

Hãy mang kính bảo hộ.



- ▶ **Dùng thiết bị dò tìm thích hợp để xác định nếu có các công trình công cộng lắp đặt ngầm trong khu vực làm việc hay liên hệ với Cty công trình công cộng địa phương để nhờ hỗ trợ.** Dụng cụ dò tìm có thể gây ra hỏa hoạn và điện giật. Làm hư hại đường dẫn khí ga có thể gây nổ. Làm thủng ống dẫn nước có thể làm hư hại tài sản hay có thể gây ra điện giật.

- ▶ **Không được chạm vào đĩa mài hay đĩa cắt trước khi các đĩa này đã nguội.** Đĩa có thể trở nên rất nóng trong lúc hoạt động.
- ▶ **Nhà công tắc Tắt/Mở ra và chuyển về vị trí tắt khi nguồn điện cung cấp bị ngắt, ví dụ., như khi rút ắc quy.** Cách này để ngăn sự khởi động lại không được kiểm soát.
- ▶ **Kẹp chặt vật gia công.** Vật gia công được kẹp bằng một thiết bị kẹp hay bằng ê-tô thì vững chắc hơn giữ bằng tay.
- ▶ **Trong trường hợp pin bị hỏng hay sử dụng sai cách, hơi nước có thể bốc ra. Pin có thể cháy hoặc nổ.** Hãy làm cho thông thoáng khí và trong trường hợp bị đau phải nhờ y tế chữa trị. Hơi nước có thể gây ngứa hệ hô hấp.
- ▶ **Không được tháo pin ra.** Nguy cơ bị chập mạch.
- ▶ **Pin có thể bị hư hại bởi các vật dụng nhọn như đinh hay tuốc-nơ-vít hoặc bởi các tác động lực từ bên ngoài.** Nó có thể dẫn tới đoản mạch nội bộ và làm pin bị cháy, bốc khói, phát nổ hoặc quá nóng.
- ▶ **Chỉ sử dụng pin trong các sản phẩm của nhà sản xuất.** Chỉ bằng cách này, pin sẽ được bảo vệ tránh nguy cơ quá tải.



Bảo vệ pin không để bị làm nóng, ví dụ, chống để lâu dài dưới ánh nắng gay gắt, lửa, chất bẩn, nước, và sự ẩm ướt. Có nguy cơ nổ và chập mạch.



- ▶ **Cẩn thận! Nếu sử dụng dụng cụ điện với công Bluetooth® có thể gây nhiễu các dụng cụ, thiết bị khác cũng như máy bay và dụng cụ y tế (ví dụ: máy tạo nhịp tim, máy trợ thính).** Và cũng không thể loại trừ hoàn toàn những tổn hại cho người và động vật ở môi trường trực diện xung quanh. Không sử dụng dụng cụ điện có kết nối Bluetooth® ở gần những thiết bị y tế, trạm xăng, cơ sở hóa học, các khu vực có nguy cơ gây nổ và các khu vực cháy nổ. Không sử dụng dụng cụ điện có kết nối Bluetooth® trên máy bay. Tránh để máy hoạt động gần cơ thể trong thời gian dài.

Biểu tượng chữ Bluetooth® cũng như biểu tượng ảnh (các logo) do công ty cổ phần Bluetooth SIG đăng ký nhãn hiệu và sở hữu. Công ty trách nhiệm hữu hạn Robert Bosch Power Tools GmbH đã được cấp phép để sử dụng những biểu tượng chữ/biểu tượng ảnh này với sản phẩm của mình.

Mô Tả Sản Phẩm và Đặc Tính Kỹ Thuật



Đọc kỹ mọi cảnh báo an toàn và mọi hướng dẫn. Không tuân thủ mọi cảnh báo và hướng dẫn được liệt kê dưới đây

có thể bị điện giật, gây cháy và / hay bị thương tật nghiêm trọng.

Xin lưu ý các hình minh hoạt trong phần trước của hướng dẫn vận hành.

Sử dụng đúng cách

Máy được thiết kế dùng để cắt, chà thô và đánh ráp vật liệu bằng kim loại và đá mà không cần sử dụng nước.

Để cắt bằng vật liệu mài nén kết, cần phải sử dụng đường cắt đặc biệt (phụ kiện).

Khi cắt đá, tạo đủ hiệu quả cho việc hút bụi.

Với loại dụng cụ đánh ráp thích hợp, máy có thể sử dụng đĩa chà để đánh ráp.

Khi Bluetooth® Low Energy Module được sử dụng, dữ liệu và các cài đặt của dụng cụ điện có thể được truyền đi giữa dụng cụ điện và một thiết bị đầu cuối di động GCY 42 bằng công nghệ sóng vô tuyến Bluetooth®.

Các bộ phận được minh họa

Sự đánh số các biểu trưng của sản phẩm là để tham khảo hình minh họa của máy trên trang hình ảnh.

- (1) Chấn bảo vệ cho chấn bảo vệ
- (2) Mũi tên chỉ chiều quay trên vỏ máy
- (3) Nút khóa trục
- (4) Giao diện người dùng
- (5) Công tắc bật/tắt
- (6) Nắp Bluetooth® Low Energy Module GCY 42
- (7) Pin^{A)}
- (8) Nút tháo pin^{A)}
- (9) Tay nắm phụ (có bề mặt nắm cách điện)
- (10) Chấn bảo vệ dùng để chà nhám
- (11) Bích lắp với vòng đệm chữ O
- (12) Đĩa mài
- (13) Đai ốc chặn
- (14) Đá mài hình chấu-kim loại cứng^{A)}
- (15) Chấn bảo vệ để cắt^{A)}
- (16) Đĩa cắt^{A)}
- (17) Tay nắm (bề mặt nắm cách điện)
- (18) trục máy mài
- (19) Chấn bảo vệ tay^{A)}
- (20) Đĩa chà cao su^{A)}
- (21) Giấy nhám^{A)}
- (22) Đai ốc tròn^{A)}
- (23) Bàn chải kim loại^{A)}
- (24) Mũi khoan kim cương^{A)}
- (25) Đèn báo trạng thái nạp pin (Giao diện người dùng)
- (26) Hiển thị chống dội ngược (Giao diện người dùng)

- (27) Nút chọn trước tốc độ (Giao diện người dùng)
 (28) Hiển thị mức tốc độ/chế độ (Giao diện người dùng)
 (29) Hiển thị Smartphone (Giao diện người dùng)
 (30) Hiển thị Trạng thái dụng cụ điện (Giao diện người dùng)
- (31) Hiển thị nhiệt độ (Giao diện người dùng)
 (32) Dĩa chà gấp nếp^{A)}
 A) Phụ tùng được trình bày hay mô tả không phải là một phần của tiêu chuẩn hàng hóa được giao kèm theo sản phẩm. Bạn có thể tham khảo tổng thể các loại phụ tùng, phụ kiện trong chương trình phụ tùng của chúng tôi.

Thông số kỹ thuật

Máy mài dạng góc		GWS 18V-15 C	GWS 18V-15 SC
Mã số máy		3 601 JH6 0..	3 601 JH6 1..
Điện thế danh định	V=	18	18
Tốc độ danh định ^{A)}	min ⁻¹	11000	11000
Tốc độ không tải ^{B)}	min ⁻¹	9800	3400–9800
Đường kính đĩa mài, tối đa	mm	100	100
Đường ren của trục máy mài		M 10	M 10
Chiều dài ren (tối đa) của trục máy mài	mm	16	16
Chống dội ngược		●	●
Chống sự khởi động lại		●	●
Hãm trơn quay		●	●
Chọn trước tốc độ		–	●
Trọng lượng theo EPTA-Procedure 01:2014 ^{C)}			
– cùng với tay nắm giảm chấn phụ	kg	2,5–3,5	2,5–3,5
– cùng với tay nắm tiêu chuẩn phụ	kg	2,3–3,3	2,3–3,3
Nhiệt độ môi trường được khuyến nghị khi sạc	°C	0 ... +35	0 ... +35
Nhiệt độ môi trường cho phép khi vận hành ^{D)} và khi bảo quản	°C	-20 ... +50	-20 ... +50
Pin tương thích		GBA 18V... ProCORE18V...	GBA 18V... ProCORE18V...
Pin được khuyến dùng cho công suất tối đa		ProCORE18V... ≥ 5,5 Ah	ProCORE18V... ≥ 5,5 Ah
Thiết bị nạp được giới thiệu		GAL 18... GAX 18... GAL 36...	GAL 18... GAX 18... GAL 36...

Truyền dữ liệu

Bluetooth®		Bluetooth® 4.2 (Low Energy) ^{E)}	Bluetooth® 4.2 (Low Energy) ^{E)}
Khoảng cách giữa các tín hiệu	s	8	8
Phạm vi tín hiệu tối đa ^{F)}	m	30	30

A) Tốc độ đo theo tiêu chuẩn EN 60745-2-3

B) Được đo ở nhiệt độ 20–25 °C với pin ProCORE18V 8.0Ah và phụ thuộc vào mức sạc của pin cũng như nhiệt độ vận hành của thiết bị

C) tùy vào loại pin lốc đang sử dụng

D) hiệu suất giới hạn ở nhiệt độ <0 °C

E) Các thiết bị di động đầu cuối phải tương thích với các thiết bị Bluetooth® Low Energy (Phiên bản 4.2) và phải hỗ trợ chế độ Generic Access Profile (GAP).

F) Phạm vi có thể biến đổi mạnh tùy thuộc vào điều kiện bên ngoài, bao gồm thiết bị thu nhận được dùng. Trong các phòng kín và qua các rào chắn kim loại (ví dụ tường, giá, va li, v.v.) phạm vi Bluetooth® có thể nhỏ hơn.

Sự lắp vào

Hãy lắp Bluetooth® Low Energy Module GCY 42

Lưu ý: Ở các dụng cụ điện GWS 18V-15 C, Bluetooth® Low Energy Module GCY 42 được sử dụng như phụ kiện; ở các dụng cụ điện GWS 18V-15 SC, nó được đi kèm sẵn phẩm.

Để biết thông tin về Bluetooth® Low Energy Module **GCY 42**, hãy đọc hướng dẫn vận hành đi kèm.

Sạc pin

- **Chỉ sử dụng bộ sạc được đề cập trong dữ liệu kỹ thuật.** Chỉ những bộ sạc này phù hợp cho dụng cụ điện cầm tay của bạn có sử dụng pin Li-Ion.

Hướng dẫn: Pin đã được sạc một phần. Để bảo đảm đầy đủ điện dung, nạp điện hoàn toàn lại cho pin trong bộ nạp điện pin trước khi sử dụng cho lần đầu tiên.

Pin Li-Ion hợp khối có thể nạp điện bất cứ lúc nào mà không làm giảm tuổi thọ của pin. Sự gián đoạn trong quá trình nạp điện không làm hư hại pin hợp khối.

Pin Li-Ion được bảo vệ ngăn sự phóng điện quá lớn nhờ vào "Electronic Cell Protection (ECP)". Nếu pin bị phóng điện, dụng cụ điện cầm tay sẽ được ngắt bởi một mạch bảo vệ: Dụng cụ điện không chuyển động nữa.

- **Có nguy cơ gây thương tích khi vô tình làm kích hoạt công tắc Tắt/Mở.** Pin có thể bị hỏng.

Quy trình hoạt động được chia ra làm hai giai đoạn.

Tháo pin ra

Pin (7) có hai mức khóa, có nhiệm vụ ngăn ngừa pin bị rơi ra do vô ý bấm phải nút tháo pin (8). Cứ khi nào pin còn được lắp trong dụng cụ điện, nó vẫn được giữ nguyên vị trí nhờ vào một lò xo.

Để tháo pin (7) bạn hãy ấn nút mở (8) và đẩy pin ra khỏi dụng cụ điện cầm tay. **Không dùng sức.**

Đèn báo trạng thái nạp pin

Các đèn LED màu xanh của màn hình hiển thị tình trạng sạc pin chỉ ra tình trạng sạc của pin. Vì lý do an toàn, ta chỉ có thể kiểm tra trạng thái của tình trạng nạp điện khi máy đã ngừng hoạt động hoàn toàn.

Để hiển thị tình trạng nạp, bạn hãy nhấn nút để hiển thị mức sạc ☺ hoặc ☹. Điều này cũng có thể thực hiện khi ắc quy được tháo ra.

Đèn LED không sáng sau khi nhấn nút để hiển thị mức sạc có nghĩa là pin bị hỏng và phải được thay thế.

Lưu ý: Mức sạc pin cũng được hiển thị trên giao diện người dùng (4) (xem „Hiển thị trạng thái“, Trang 82).

Kiểu pin GBA 18V...



Đèn LED	Điện dung
Đèn sáng liên tục 3× xanh lục	60–100 %
Đèn sáng liên tục 2× xanh lục	30–60 %
Đèn sáng liên tục 1× xanh lục	5–30 %
Đèn xi nhan 1× xanh lục	0–5 %

Kiểu pin ProCORE18V...



Đèn LED	Điện dung
Đèn sáng liên tục 5× xanh lục	80–100 %
Đèn sáng liên tục 4× xanh lục	60–80 %
Đèn sáng liên tục 3× xanh lục	40–60 %
Đèn sáng liên tục 2× xanh lục	20–40 %
Đèn sáng liên tục 1× xanh lục	5–20 %
Đèn xi nhan 1× xanh lục	0–5 %

Lắp bộ phận bảo vệ vào

- **Trước khi tiến hành bất cứ công việc gì với máy (ví dụ bảo dưỡng, thay dụng cụ v.v..) cũng như khi vận chuyển hay lưu kho, tháo pin ra khỏi dụng cụ điện.** Có nguy cơ gây thương tích khi vô tình làm kích hoạt công tắc Tắt/Mở.

Hướng dẫn: Trong quá trình vận hành mà sau đó đĩa bị vỡ hay các chi tiết dùng lắp ráp nằm trên chắn bảo vệ/dụng cụ điện bị hỏng, máy phải được mang đến ngay đại lý phục vụ hàng sau khi bán để bảo trì, sửa chữa (để biết địa chỉ liên hệ, xin xem Phần „Dịch vụ hỗ trợ khách hàng và tư vấn sử dụng“).

Nắp bảo vệ dùng để chà nhám

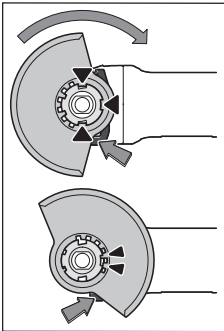

Hãy đặt nắp bảo vệ (10) lên phần lắp ở dụng cụ điện, cho đến khi các vấu mã hóa của nắp bảo vệ khớp với phần lắp. Khi đó hãy nhấn và giữ cần nhả khóa (1).

Hãy ấn nắp bảo vệ (10) lên cổ trục cho đến khi gờ dềng chuỗi của nắp bảo vệ áp vào mặt bích của dụng cụ điện và vận nắp bảo vệ, cho đến khi nó khớp vào.

Điều chỉnh vị trí của nắp

bảo vệ (10) phù hợp với yêu cầu của quá trình làm việc. Hãy nhấn cần nhả khóa (1) lên trên và xoay nắp bảo vệ (10) vào vị trí mong muốn.

- ▶ Luôn điều chỉnh nắp bảo vệ (10) sao cho cả hai cam của cần nhả khóa (1) khớp vào các khe tương ứng của nắp bảo vệ. (10)
- ▶ Hãy điều chỉnh chắn bảo vệ lưới (10) sao cho có thể ngăn được tia lửa điện bay theo hướng người điều khiển.
- ▶ Chắn bảo vệ lưới (10) chỉ được xoay khi kích hoạt cần nhả khóa (1)! Nếu không, dụng cụ điện sẽ không được phép dùng trong mọi trường hợp và phải được giao cho dịch vụ khách hàng.

Hướng dẫn: Vấu mã hóa ở nắp bảo vệ (10) đảm bảo rằng chỉ có một nắp bảo vệ phù hợp với dụng cụ điện có thể được lắp đặt.

Chắn Bảo Vệ Dùng Để Cắt

- ▶ Khi cắt bằng chất liệu mài nén kết, luôn luôn sử dụng chắn bảo vệ để cắt (15).
- ▶ Tạo đủ hiệu quả cho việc hút bụi khi cắt đá.

Chắn bảo vệ dùng để cắt (15) được lắp vào giống như cách lắp chắn bảo vệ dùng để chà nhám (10).

Tay nắm phụ

- ▶ Chỉ vận hành máy của bạn khi đã gắn tay nắm phụ (9).

Vận tay nắm phụ vào (9) ở bên phải hay trái đầu máy tùy theo cách thức thao tác.

Tay Nắm Phụ Chống Rung



Vibration Control

Tay nắm phụ chống rung làm giảm sự rung động, làm cho việc vận hành thêm phần dễ

chịu và an toàn.

- ▶ Không được làm thay đổi tay nắm phụ bất cứ điều gì.

Không được tiếp tục sử dụng tay nắm phụ nếu đã bị hư hỏng.

Chắn Bảo Vệ Tay

- ▶ Dùng cho việc vận hành với đĩa chà cao su (20) hay với bàn chải kim loại/bàn chải đĩa/đĩa chà gấp nếp, luôn luôn gắn chắn bảo vệ tay vào (19).

Chắn bảo vệ tay (19) được bắt chặt cùng với tay nắm phụ (9).

Lắp Dụng Cụ Mài

- ▶ Trước khi tiến hành bất cứ công việc gì với máy (ví dụ bảo dưỡng, thay dụng cụ v.v..) cũng như khi vận chuyển hay lưu kho, tháo pin ra khỏi dụng cụ điện. Có nguy cơ gây thương tích khi vô tình làm kích hoạt công tắc Tắt/Mở.
 - ▶ Không được chạm vào đĩa mài hay đĩa cắt trước khi các đĩa này đã nguội. Đĩa có thể trở nên rất nóng trong lúc hoạt động.
- Làm sạch trục máy mài (18) và tất cả bộ phận sắp được lắp vào.
- Để cạy chặt hay tháo lỏng dụng cụ mài, khóa trục máy mài bằng nút khóa trục (3).
- ▶ Chỉ cho nút khóa trục hoạt động khi trục máy mài đã đứng yên. Nếu không, máy có thể bị làm hỏng.

Đĩa Mài/Cắt

Hãy lưu ý đến kích cỡ của dụng cụ mài. Đường kính của lỗ lắp dụng cụ phải vừa khít với bích lắp dụng cụ mà không có khe hở. Không được sử dụng bộ phận thu nhỏ hay bộ phận tiếp hợp.

Khi sử dụng đĩa cắt kim cương, hãy lưu ý mũi tên chỉ chiều quay trên đĩa cắt kim cương và chiều quay của dụng cụ điện phải cùng chiều (xem phần mũi tên chỉ chiều quay in dập trên đầu máy).

Xem trang đồ họa để biết các bước lắp ráp.

Để vận chặt đĩa mài/cắt, vận đai ốc chặn vào (13) và siết chặt lại bằng chia vận hai chấu.

- ▶ Sau khi lắp dụng cụ mài và trước khi mở máy, kiểm tra xem dụng cụ mài có lắp vào đúng cách không và có thể quay tự do không. Đảm bảo dụng cụ mài không chạm vào chắn bảo vệ hay các bộ phận khác.

Đĩa chà gấp nếp

- ▶ Để vận hành với đĩa chà gấp nếp, hãy luôn gắn chắn bảo vệ tay vào (19).

Đĩa Chà Cao Su

- ▶ Để vận hành với đĩa chà cao su (20) luôn gắn chắn bảo vệ tay vào (19).

Xem trang hình ảnh để biết các bước lắp ráp.

Hãy đẩy đĩa chà cao su (20) trên trục mài chính (18).

Hãy ấn giấy nhám (21) thật chặt lên mặt dưới của đĩa chà cao su (20).

Hãy vận đai ốc tròn (22) vào và siết chặt lại bằng chia vận hai chấu.

Bàn Chải kim loại/Bàn Chải Đĩa

- Để vận hành với bàn chải kim loại hoặc bàn chải đĩa, hãy luôn gắn chắn bảo vệ tay vào (19).

Xem trang hình ảnh để biết các bước lắp ráp.

Bàn chải kim loại/bàn chải đĩa phải vận được hết vào tận vòng ren cuối của trục máy mài cho đến khi nằm chắc sát vào bích lắp của trục máy mài. Siết chặt bàn chải kim loại/bàn chải đĩa lại bằng khóa mở miệng hai chấu.

Đá mài hình chấu cho kim loại cứng





- Chỉ được sử dụng đá mài hình chấu với chắn bảo vệ lưới phù hợp.

Các dụng cụ mài được chấp nhận

Tất cả các dụng cụ mài được đề cập trong các trang hướng dẫn sử dụng đều có thể sử dụng.

Số vòng quay cho phép [min^{-1}] hoặc vận tốc vòng [m/s] của dụng cụ mài đã sử dụng phải tương ứng với các thông số trong bảng sau đây.

Do đó hãy lưu ý số vòng quay cho phép **hoặc vận tốc vòng** trên nhãn của dụng cụ mài.

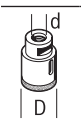
	max. [mm]		[mm]		
	D	b	d	[min^{-1}]	[m/s]
	100	7	16	11000	80
	100	–	–	11000	80
	75	30	M 14	11000	45
	82	–	M 14	11000	80

Xoay đầu máy (GWS 18V-15 C)

- Trước khi tiến hành bất cứ công việc gì với máy (ví dụ bảo dưỡng, thay dụng cụ v.v.) cũng như khi vận chuyển hay lưu kho, tháo pin ra khỏi dụng cụ điện. Có nguy cơ gây thương tích khi vô tình làm kích hoạt công tắc Tắt/Mở.

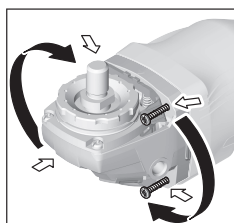

Đầu máy có thể xoay được đối với vỏ máy ở vào 90 độ. Bằng cách này, công tắc Tắt/Mở có thể chuyển đặt ở vị trí thuận tiện hơn cho những tình huống thao tác đặc biệt. Ví dụ., cho người thuận tay trái. Tháo hết cả 4 vít ra.

Xoay đầu máy thật cẩn thận, **mà không để rời ra khỏi vỏ máy**, về vị trí mới. Bắt vít vào và siết chặt cả 4 vít lại lần nữa.

Hút Dăm/Bụi

Mạt bụi từ các vật liệu được sơn phủ ngoài có chứa chì trên một số loại gỗ, khoáng vật và kim loại có thể gây nguy hại đến sức khoẻ con người. Đụng chạm hay hít thở các bụi này có thể làm người sử dụng hay đứng gần bị dị ứng và/hoặc gây nhiễm trùng hệ hô hấp.

Một số hạt bụi cụ thể, ví dụ như bụi gỗ sồi hay đậu, được xem là chất gây ung thư, đặc biệt là có liên quan đến các chất phụ gia dùng xử lý gỗ (chất cromat, chất bảo quản gỗ). Có thể chỉ nên để thợ chuyên môn gia công các loại vật liệu có chứa amiăng.

- Tạo không khí thông thoáng nơi làm việc.
- Khuyến nghị nên mang mặt nạ phòng độc có bộ lọc cấp P2.

Tuân thủ các qui định của quốc gia bạn liên quan đến loại vật liệu gia công.

- **Tránh không để rác tích tụ tại nơi làm việc.**
Rác có thể dễ dàng bắt lửa.

Vận Hành

Bắt đầu vận hành

Tháo Pin

Hãy đẩy pin đã sạc (7) từ phía trước vào chân của dụng cụ điện cầm tay, cho đến khi pin được khóa an toàn.

Bật Mở và Tắt

Để **mở máy** dụng cụ điện, nhấn công tắc Tắt/Mở (5) về phía trước.

Để **khóa** công tắc Bật/Tắt (5) hãy nhấn công tắc Bật/Tắt (5) về phía trước, cho đến khi khớp vào.

Để tắt dụng cụ điện, hãy nhả công tắc bật/tắt (5) hoặc nếu nó được khóa, hãy nhấn nhanh công tắc bật/tắt (5) xuống và nhả.

- **Kiểm tra các dụng cụ mài trước khi sử dụng.** Dụng cụ mài phải được lắp vào đúng cách và có thể chuyển động tự do. Tiến hành chạy thử máy không tải ít nhất là 1 phút. Không được sử dụng dụng cụ mài bị hỏng, chạy

lệch tâm hay bị rung lắc. Dụng cụ mài bị hư hỏng có thể vỡ tung và gây ra thương tích.

Chống dội ngược



Khi dội ngược đột ngột của dụng cụ điện, ví dụ kẹt cứng trong đoạn cắt, nguồn điện tới động cơ bị gián đoạn. Khi đó, hiển thị Chống dội ngược (26) sẽ sáng. Khi chống dội ngược được kích hoạt, hiển thị Trạng thái (30) nhấp nháy đỏ. Để **vận hành lại** hãy đưa công tắc Bật/Tắt (5) vào vị trí tắt và bật lại dụng cụ điện.

Chống sự khởi động lại

Sự bảo vệ sự tái khởi động ngăn ngừa sự khởi động không được chủ động kiểm soát của máy sau khi mất điện.

Chọn trước tốc độ (GWS 18V-15 SC)

Trong cài đặt xuất xưởng có 3 mức tốc độ. Có thể lập trình tối đa 6 mức tốc độ qua một ứng dụng đặc biệt (Bosch Toolbox App).

Nếu số mức tốc độ được thay đổi, các giá trị của từng mức sẽ được điều chỉnh theo mặc định. Trong trường hợp này hiển thị mức tốc độ/chế độ (28) sẽ sáng trắng. Nếu giá trị tốc độ được lập trình riêng, hiển thị mức tốc độ/chế độ (28) sẽ sáng màu xanh dương ở mức tốc độ này (tức là không tương ứng với cài đặt cơ bản). Có thể điều chỉnh riêng các mức tốc độ theo các bước cứ mỗi 200 min⁻¹. Khi đó hãy lưu ý logic tăng dần của mức (2 ≥ 1 / 3 ≥ 2, ...).

Bảng sau đây hiển thị tốc độ mặc định (các cài đặt cơ bản) cho mỗi số lượng cấp độ được lập trình.

GWS 18V-15 SC	Thiết lập cơ bản số vòng quay theo cấp độ					
	1	2	3	4	5	6
	[min ⁻¹]	[min ⁻¹]	[min ⁻¹]	[min ⁻¹]	[min ⁻¹]	[min ⁻¹]
Số lượng mức tốc độ						
1	3400	–	–	–	–	–
2	3400	9800	–	–	–	–
3	3400	6600	9800	–	–	–
4	3400	5600	7600	9800	–	–
5	3400	5000	6600	8200	9800	–
6	3400	4600	6000	7200	8600	9800

Giá trị đã cho của các bậc tốc độ phụ thuộc vào pin đã sử dụng, mức sạc của pin cũng như nhiệt độ vận hành của thiết bị.

Với nút để chọn trước tốc độ (27), bạn có thể chọn trước số vòng quay cần thiết cả khi đang vận hành. Các số liệu trong bảng dưới đây là các giá trị được khuyến nghị cho cài đặt xuất xưởng với 3 mức tốc độ mặc định.

Nguyên vật liệu	Ứng dụng	Dụng cụ gài	Bậc lựa chọn tốc độ	GWS 18V-15 SC [min ⁻¹]
Kim loại	Chải, đánh rỉ sét	Bàn chải kim loại	1	3400
Thép không gỉ	Chà nhám	Đĩa sợi	2	6600
Kim loại	Chà thô	Đĩa mài	3	max
Kim loại	Tách bóc	Đĩa mài	3	max
Công trình nề, đá	Tách bóc	Đĩa cắt kim cương và mấu dulong (Chỉ cho phép cắt đá khi dùng mấu dulong)	3	max

► **Tốc độ định mức của phụ kiện tối thiểu phải bằng tốc độ tối đa được ghi trên dụng cụ**

điện cầm tay. Các phụ kiện chạy nhanh hơn tốc độ định mức của chúng có thể bị vỡ và văng ra.

Hiện thị trạng thái

Đèn báo trạng thái nạp pin (Giao diện người dùng) (25)	Ý nghĩa/Nguyên nhân	Cách khắc phục
màu xanh lá	Pin được sạc	–
vàng	Pin gần cạn	Thay hoặc sạc pin sớm
màu đỏ	Bộ nguồn cạn điện	Thay hoặc sạc pin

Hiện thị nhiệt độ (31)	Ý nghĩa/Nguyên nhân	Cách khắc phục
vàng	Đạt nhiệt độ tối hạn (Động cơ, hệ thống điện, pin)	Không cho dụng cụ điện hoạt động ở chế độ không tải và hãy để nguội
màu đỏ	Dụng cụ điện bị quá nóng và bị tắt	Để nguội dụng cụ điện

Hiện thị trạng thái dụng cụ điện (30)	Ý nghĩa/Nguyên nhân	Cách khắc phục
màu xanh lá	Trạng thái OK	–
vàng	Đạt nhiệt độ tối hạn hoặc ắc quy gần cạn	Không cho dụng cụ điện hoạt động ở chế độ không tải và hãy để nguội, thay hoặc sạc ắc quy sớm
sáng đỏ	Dụng cụ điện bị quá nhiệt hoặc ắc quy cạn	Để nguội dụng cụ điện, thay hoặc sạc ắc quy
nhấp nháy đỏ	Chế độ chống dội ngược, chống khởi động lại hoặc ngắt va chạm được kích hoạt	Tắt dụng cụ điện và bật lại
nháy xanh dương	Dụng cụ điện được kết nối với thiết bị đầu cuối di động hoặc các cài đặt được truyền đi	–

Các chức năng kết nối

Các chức năng kết nối sau đây của dụng cụ điện sẽ khả dụng khi kết hợp với *Bluetooth*® Low Energy Module **GCY 42**:

- Đăng ký và cá nhân hóa
- Kiểm tra trạng thái, phát các thông báo cảnh báo
- Các thông tin và cài đặt chung
- Quản lý

Để biết thông tin về *Bluetooth*® Low Energy Module **GCY 42**, hãy đọc hướng dẫn vận hành đi kèm.

Kết nối của dụng cụ điện với ứng dụng phải được kích hoạt bằng cách nhấn nút chọn trước tốc độ (27) ở giao diện người dùng (4). Ứng dụng yêu cầu khi kết nối.

Hướng dẫn sử dụng

- ▶ **Dụng cụ điện có *Bluetooth*® Low Energy Module GCY 42 được trang bị một giao diện sóng vô tuyến. Hãy chú ý các giới hạn địa điểm hoạt động ví dụ như trên máy bay hoặc bệnh viện.**

- ▶ **Trong các vùng, mà công nghệ sóng vô tuyến *Bluetooth*® không được phép sử dụng, phải tháo *Bluetooth*® Low Energy Module GCY 42 và pin nút áo.**
- ▶ **Vận dụng sự thận trọng khi cắt rãnh vào các vách tường có cấu trúc phức hợp, xem „Phân Thông Tin Về Cấu Trúc“.**
- ▶ **Kẹp chặt vật gia công nếu vật đó không cố định được do sức nặng của chính nó.**
- ▶ **Không được bắt dụng cụ điện làm việc quá sức đến mức dừng hoạt động.**
- ▶ **Sau khi để dụng cụ điện hoạt động với cường độ cao, tiếp tục cho máy chạy không tải vài phút để làm nguội dụng cụ cắt/mài xuống.**
- ▶ **Không được sử dụng dụng cụ điện cùng chung với giá cắt.**
- ▶ **Không được chạm vào đĩa mài hay đĩa cắt trước khi các đĩa này đã nguội. Đĩa có thể trở nên rất nóng trong lúc hoạt động.**

Khi dụng cụ điện bị nhiễm tĩnh điện, bộ phận kiểm soát điện tử gắn trong máy sẽ ngắt mạch. Hãy

nhấn lại công tắc bật/tắt (5), để vận hành lại dụng cụ điện.

Chà Thô

► Không bao giờ được sử dụng đĩa cắt để chà thô.

Hiệu quả chà thô tốt nhất đạt được là khi ta chính đặt máy ở góc từ 30° đến 40°. Di chuyển máy qua lại với lực áp máy vừa phải. Do đó, bộ phận máy sẽ không quá nóng, không bị đổi màu và không có rãnh.

Đĩa chà gấp nếp

Với đĩa chà gấp nếp (phụ kiện), ta có thể gia công vật liệu có bề mặt cong và nghiêng. Đĩa chà gấp nếp có tuổi tương đối cao hơn đáng kể, độ ồn thấp và nhiệt độ chà thấp hơn so với đĩa chà thông thường.

Cắt Kim Loại

► Khi cắt bằng chất liệu mài nén kết, luôn luôn sử dụng chấn bảo vệ để cắt (15).

Khi cắt, gia công với mức độ vừa phải, tuân theo loại vật liệu đang cắt mà gia công cho thích hợp. Không được tạo áp lực lên đĩa cắt, không làm máy bị nghiêng hay dao động.

Không được làm giảm tốc độ đang quay của đĩa xuống bằng cách tạo lực hãm lên một bên mặt hông đĩa.

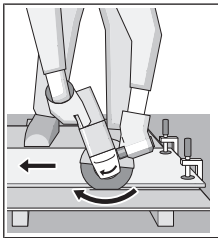

Máy luôn luôn phải được vận hành theo chuyển động mài ở tư thế thẳng đứng. Nếu không như vậy, có nguy cơ bị đẩy mà không điều khiển được máy ra khỏi mạch cắt.

Khi cắt một thanh vật liệu có mặt nghiêng và

góc vuông, tốt nhất là bắt đầu tại điểm có thiết diện nhỏ nhất.

Cắt Đá

► Tạo đủ hiệu quả cho việc hút bụi khi cắt đá.

► Hãy mang mặt nạ chống bụi.

► Máy có thể chỉ được sử dụng để cắt/mài khô.

Để cắt đá, cách tốt nhất là sử dụng đĩa cắt kim cương.

Khi cắt vật liệu đặc biệt cứng, ví dụ Bê-tông có hàm lượng sỏi cao, đĩa cắt kim cương có thể quá nhiệt và bị hư hại. Tia lửa bắn ra vòng tròn là biểu hiện của đĩa cắt kim cương bị hiện tượng trên.

Trong trường hợp này, hãy ngưng quá trình cắt và cho đĩa cắt kim cương chạy không tải ở tốc độ cao nhất trong thời gian ngắn để làm nguội.

Tiến độ gia công bị giảm thấy rõ và tia lửa bắn ra vòng tròn là biểu hiện của đĩa cắt kim cương đã bắt đầu cùn. Bạn có thể làm sắc đĩa cắt kim cương

bằng đường cắt ngắn trong vật liệu mài, ví dụ như đá vôi.

Thông Tin Về Cấu Trúc

Cắt rãnh trên các vách tường có kết cấu phức hợp phải tuân theo Tiêu chuẩn DIN 1053 Phần 1, hay theo qui định của nước sở tại. Những qui định này phải được tuân thủ trong mọi tình huống. Trước khi tiến hành công việc, hãy tham khảo ý kiến của kỹ sư thiết kế, kiến trúc sư hay người giám sát công trình có trách nhiệm.

Lưu ý về cách sử dụng tối ưu ắc quy

Bảo vệ pin hợp khối tránh sự ẩm ướt và nước.

Chỉ bảo quản pin trong tầm nhiệt độ từ -20 °C đến 50 °C. Không để pin trong ô tô vào mùa hè.

Thỉnh thoảng làm sạch các khe thông gió của pin bằng cách dùng một cái cọ khô, mềm và sạch.

Sự giảm sút đáng kể thời gian hoạt động sau khi nạp điện chỉ rõ rằng pin hợp khối đã hết công dụng và phải được thay.

Quy trình hoạt động được chia ra làm hai giai đoạn.

Bảo Dưỡng và Bảo Quản

Bảo Dưỡng Và Làm Sạch

► Trước khi tiến hành bất cứ công việc gì với máy (ví dụ bảo dưỡng, thay dụng cụ v.v.) cũng như khi vận chuyển hay lưu kho, tháo pin ra khỏi dụng cụ điện. Có nguy cơ gây thương tích khi vô tình làm kích hoạt công tắc Tắt/Mở.

► Để được an toàn và máy hoạt động đúng chức năng, luôn luôn giữ máy và các khe thông gió được sạch.

Xin vui lòng bảo quản và giữ gìn tay nắm và phụ tùng cẩn thận.

Dịch vụ hỗ trợ khách hàng và tư vấn sử dụng

Bộ phận phục vụ hàng sau khi bán của chúng tôi trả lời các câu hỏi liên quan đến việc bảo dưỡng và sửa chữa các sản phẩm cũng như phụ tùng thay thế của bạn. Sơ đồ mô tả và thông tin về phụ tùng thay thế cũng có thể tra cứu theo dưới đây: www.bosch-pt.com

Đội ngũ tư vấn sử dụng của Bosch sẽ giúp bạn giải đáp các thắc mắc về sản phẩm và phụ kiện.

Trong tất cả các phản hồi và đơn đặt phụ tùng, xin vui lòng luôn luôn nhập số hàng hóa 10 chữ số theo nhãn của hàng hóa.

Việt Nam

CN CÔNG TY TNHH BOSCH VIỆT NAM TẠI TP.HCM

Tầng 14, Ngõ Nhà Đức, 33 Lê Duẩn
Phường Bến Nghé, Quận 1, Thành Phố Hồ Chí Minh

Tel.: (028) 6258 3690
Fax: (028) 6258 3692 - 6258 3694
Hotline: (028) 6250 8555
Email: tuvankhachhang-pt@vn.bosch.com
www.bosch-pt.com.vn
www.baohanhbosch-pt.com.vn

Xem thêm địa chỉ dịch vụ tại:

www.bosch-pt.com/serviceaddresses

Vận chuyển

Pin có chứa Li-Ion là đối tượng phải tuân theo các qui định của Pháp Luật về Hàng Hóa Nguy Hiểm. Người sử dụng có thể vận chuyển pin hợp khối bằng đường bộ mà không cần thêm yêu cầu nào khác.

Khi được vận chuyển thông qua bên thứ ba (vd. vận chuyển bằng đường hàng không hay đại lý giao nhận), phải tuân theo các yêu cầu đặc biệt về đóng gói và dán nhãn. Phải tham vấn chuyên gia về hàng hóa nguy hiểm khi chuẩn bị gói hàng.

Chỉ gửi pin hợp khối khi vỏ ngoài không bị hư hỏng. Dán băng keo hay che kín các điểm tiếp xúc hở và đóng gói pin hợp khối theo cách sao cho pin không thể xê dịch khi nằm trong bao bì. Ngoài ra, xin vui lòng chấp hành các qui định chi tiết có thể được bổ sung thêm của quốc gia.

Sự thải bỏ



Dụng cụ điện, pin, phụ kiện và bao bì cần được tái sử dụng theo quy định về môi trường.



Bạn không được ném dụng cụ điện và pin vào thùng rác gia đình!

Pin/ắc quy:

Li-Ion:

Tuân thủ những hướng dẫn trong phần vận chuyển (xem „Vận chuyển“, Trang 84).

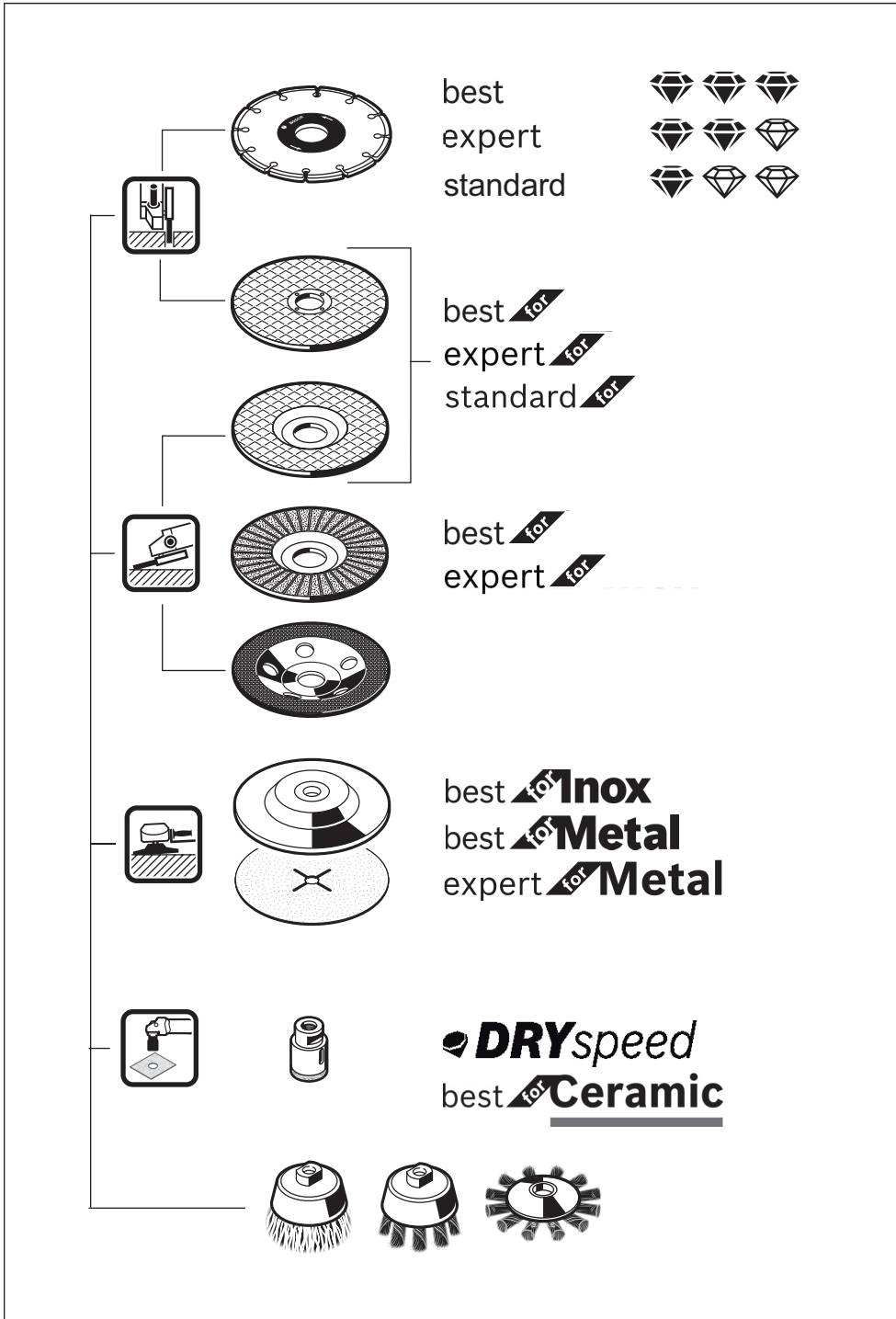

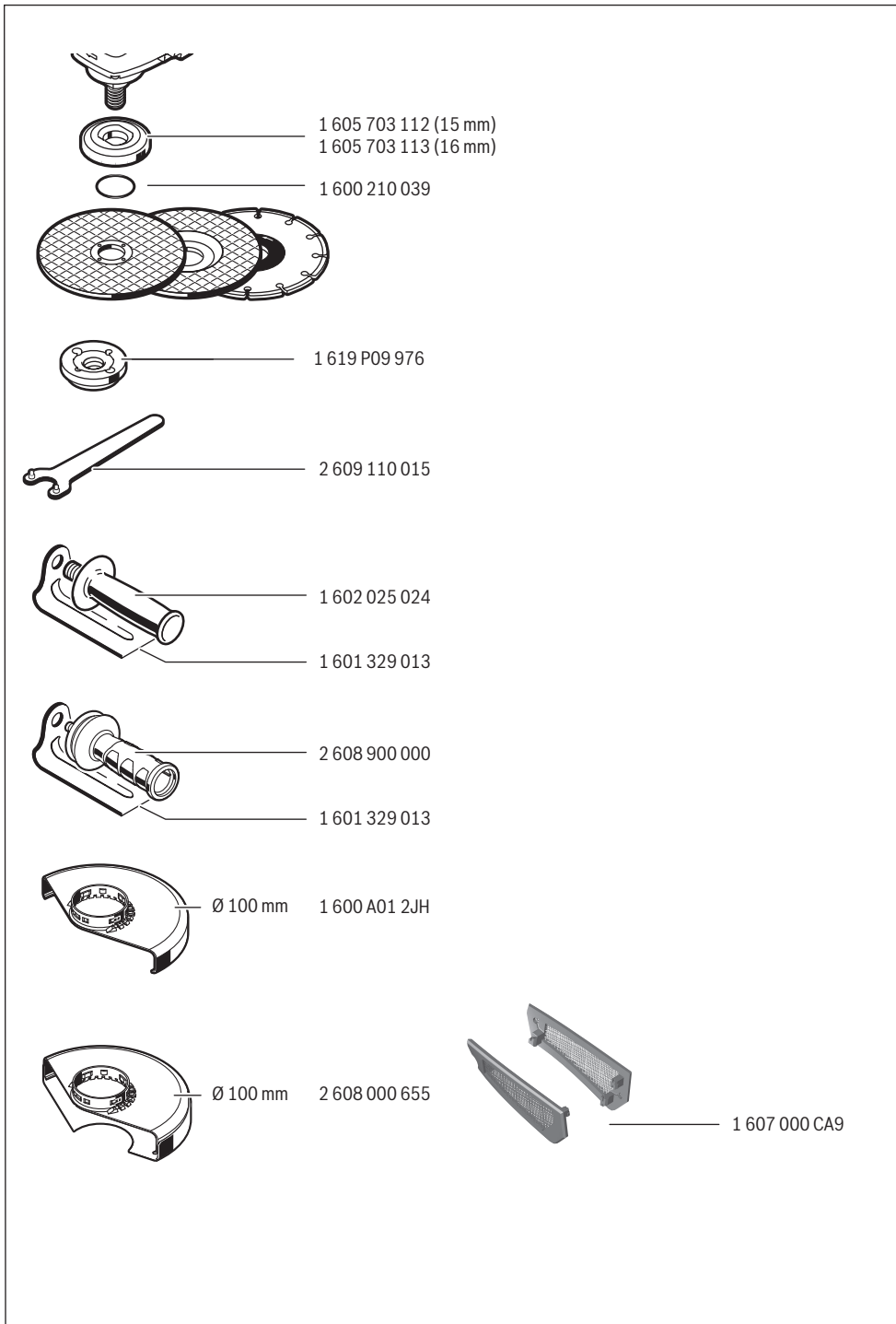

Licenses

Copyright © 2009–2016 ARM LIMITED

All rights reserved.

Redistribution and use in source and binary forms, with or without modification, are permitted provided that the following conditions are met:

- Redistributions of source code must retain the above copyright notice, this list of conditions and the following disclaimer.
- Redistributions in binary form must reproduce the above copyright notice, this list of conditions and the following disclaimer in the documentation and/or other materials provided with the distribution.
- Neither the name of ARM nor the names of its contributors may be used to endorse or promote products derived from this software without specific prior written permission.

THIS SOFTWARE IS PROVIDED BY THE COPYRIGHT HOLDERS AND CONTRIBUTORS "AS IS" AND ANY EXPRESS OR IMPLIED WARRANTIES, INCLUDING, BUT NOT LIMITED TO, THE IMPLIED WARRANTIES OF MERCHANTABILITY AND FITNESS FOR A PARTICULAR PURPOSE ARE DISCLAIMED. IN NO EVENT SHALL THE COPYRIGHT OWNER OR CONTRIBUTORS BE LIABLE FOR ANY DIRECT, INDIRECT, INCIDENTAL, SPECIAL, EXEMPLARY, OR CONSEQUENTIAL DAMAGES (INCLUDING, BUT NOT LIMITED TO, PROCUREMENT OF SUBSTITUTE GOODS OR SERVICES; LOSS OF USE, DATA, OR PROFITS; OR BUSINESS INTERRUPTION) HOWEVER CAUSED AND ON ANY THEORY OF LIABILITY, WHETHER IN CONTRACT, STRICT LIABILITY, OR TORT (INCLUDING NEGLIGENCE OR OTHERWISE) ARISING IN ANY WAY OUT OF THE USE OF THIS SOFTWARE, EVEN IF ADVISED OF THE POSSIBILITY OF SUCH DAMAGE.

Copyright © 2016–2019 STMicroelectronics

All rights reserved.

Redistribution and use in source and binary forms, with or without modification, are permitted provided that the following conditions are met:

- Redistributions of source code must retain the above copyright notice, this list of conditions and the following disclaimer.
- Redistributions in binary form must reproduce the above copyright notice, this list of conditions and the following disclaimer in the documentation and/or other materials provided with the distribution.
- Neither the name of STMicroelectronics nor the names of its contributors may be used to endorse or promote products derived from this software without specific prior written permission.

THIS SOFTWARE IS PROVIDED BY THE COPYRIGHT HOLDERS AND CONTRIBUTORS "AS IS" AND ANY EXPRESS OR IMPLIED WARRANTIES, INCLUDING, BUT NOT LIMITED TO, THE IMPLIED WARRANTIES OF MERCHANTABILITY AND FITNESS FOR A PARTICULAR PURPOSE ARE DISCLAIMED. IN NO EVENT SHALL THE COPYRIGHT OWNER OR CONTRIBUTORS BE LIABLE FOR ANY DIRECT, INDIRECT, INCIDENTAL, SPECIAL, EXEMPLARY, OR CONSEQUENTIAL DAMAGES (INCLUDING, BUT NOT LIMITED TO, PROCUREMENT OF SUBSTITUTE GOODS OR SERVICES; LOSS OF USE, DATA, OR PROFITS; OR BUSINESS INTERRUPTION) HOWEVER CAUSED AND ON ANY THEORY OF LIABILITY, WHETHER IN CONTRACT, STRICT LIABILITY, OR TORT (INCLUDING NEGLIGENCE OR OTHERWISE) ARISING IN ANY WAY OUT OF THE USE OF THIS SOFTWARE, EVEN IF ADVISED OF THE POSSIBILITY OF SUCH DAMAGE.